



# **PAVILION 12/4**

Assembly Guide

# LIST OF DETAILS

## Wall elements

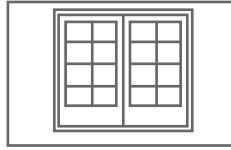
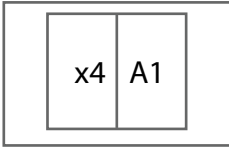

x1  
A2

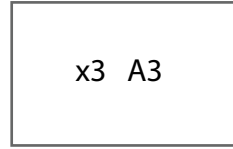

## Roof elements

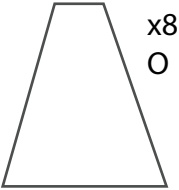



## Roof hat

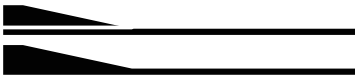

x1  
P

## Corner cover elements



 x8 B1  
 x8 B2

## Fluted brim planks



x8 C

## Triangle details



x8 D

## Inner corner strips



x8 F

## Floor strips







x8 F1

## Roof's inner strips



x8 G

### Window strips

-  x4 K1
-  x4 K2
-  x4 K5
-  x4 K3
-  x4 K4

### Chimney hole cover

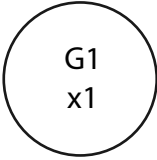

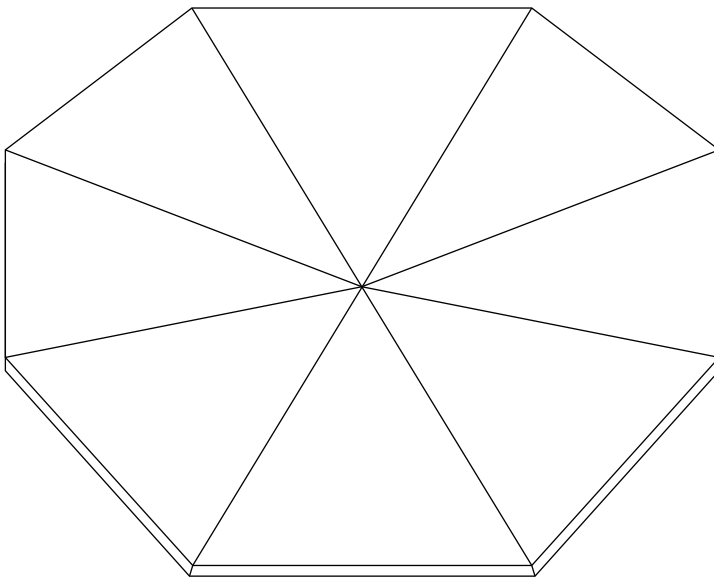

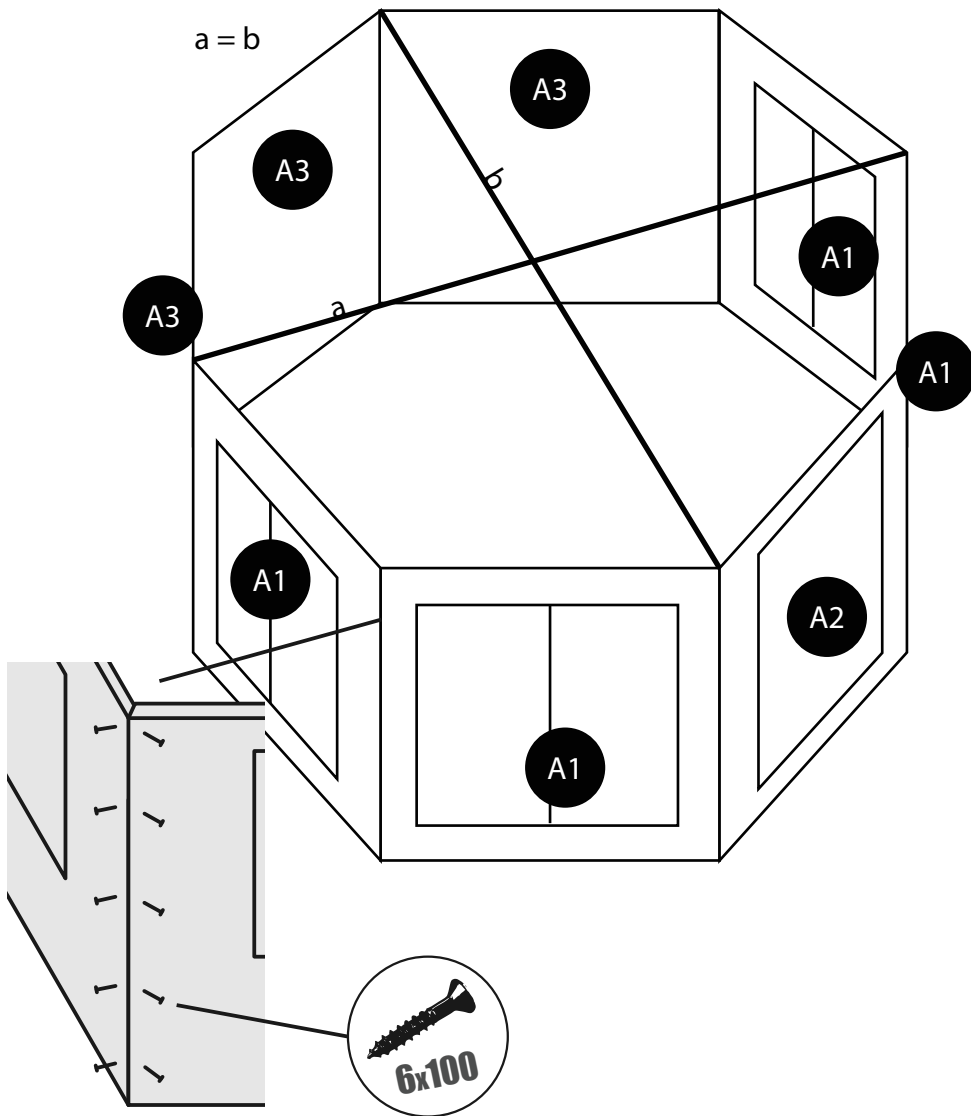

Attach the wall elements to each other using 10 screws per corner. The wall element with the openable window should be opposite to the wall element for the door.

6

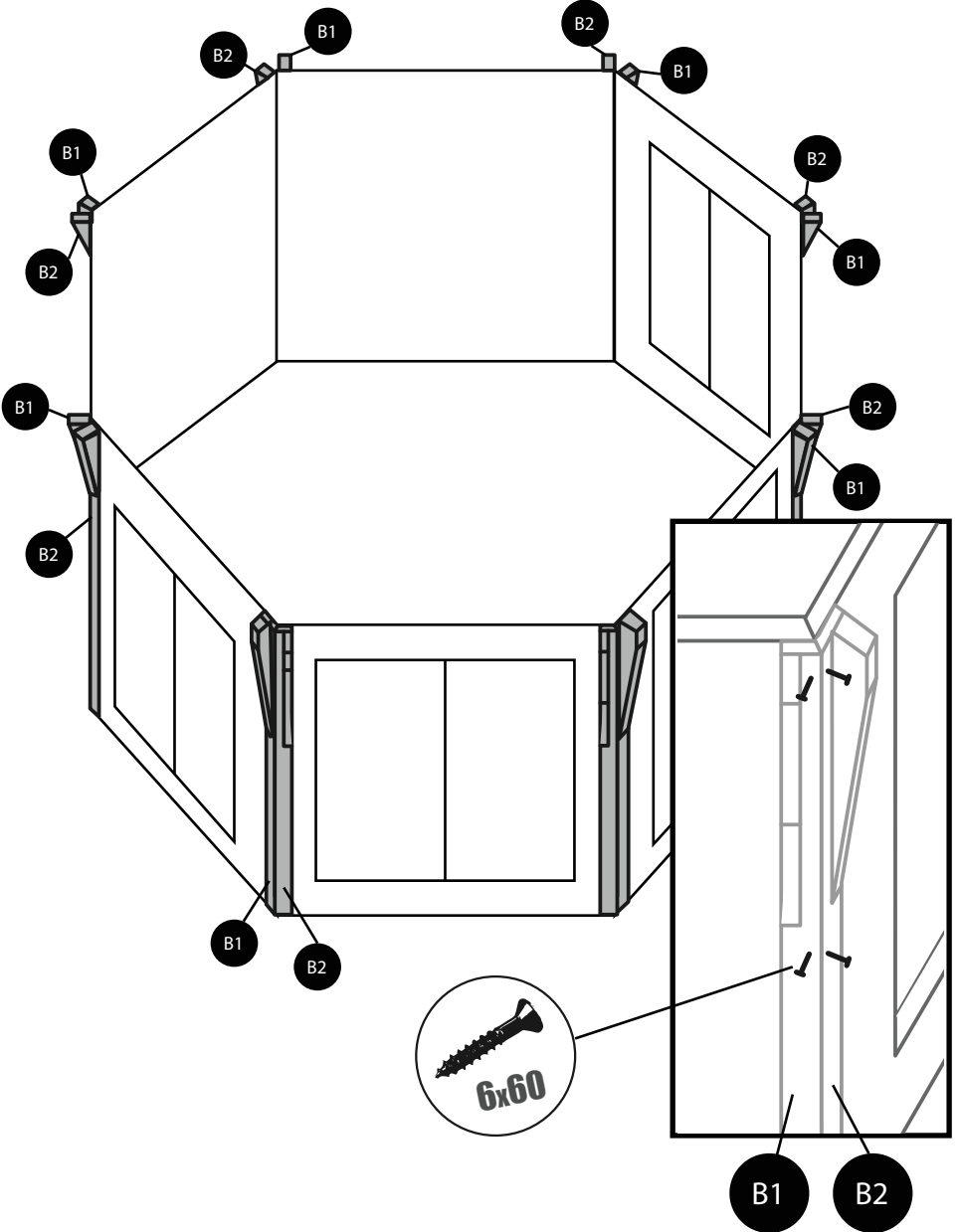

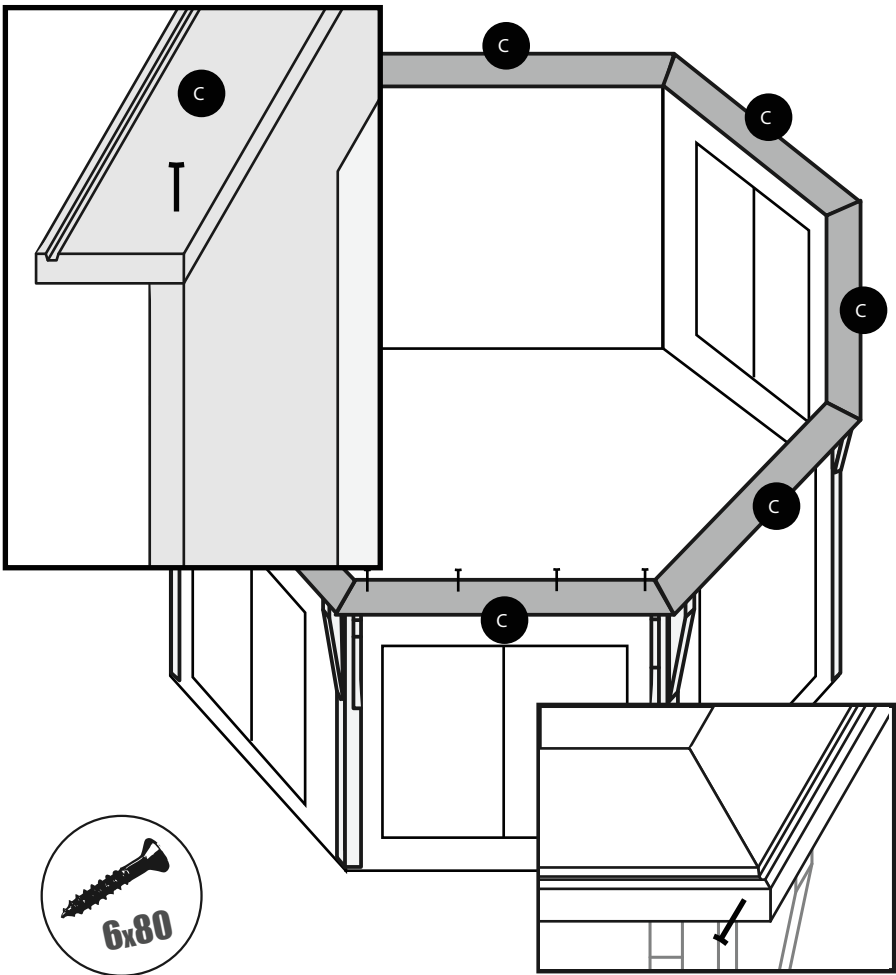

Make sure the planks inner edge is even with the walls inner side and that the corners fit nicely.

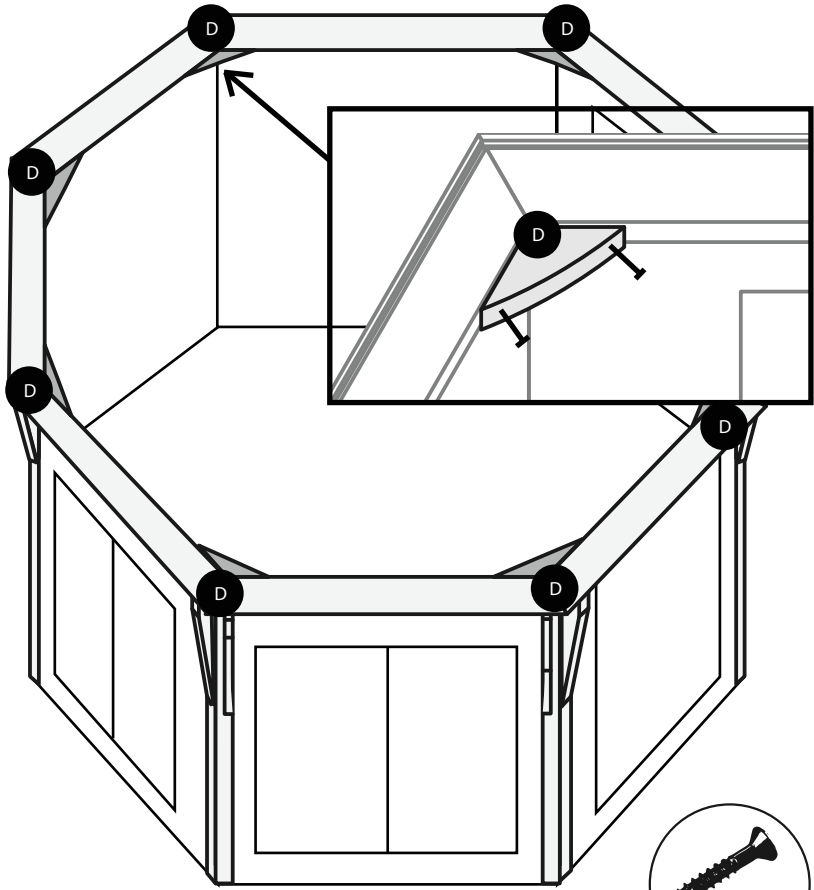



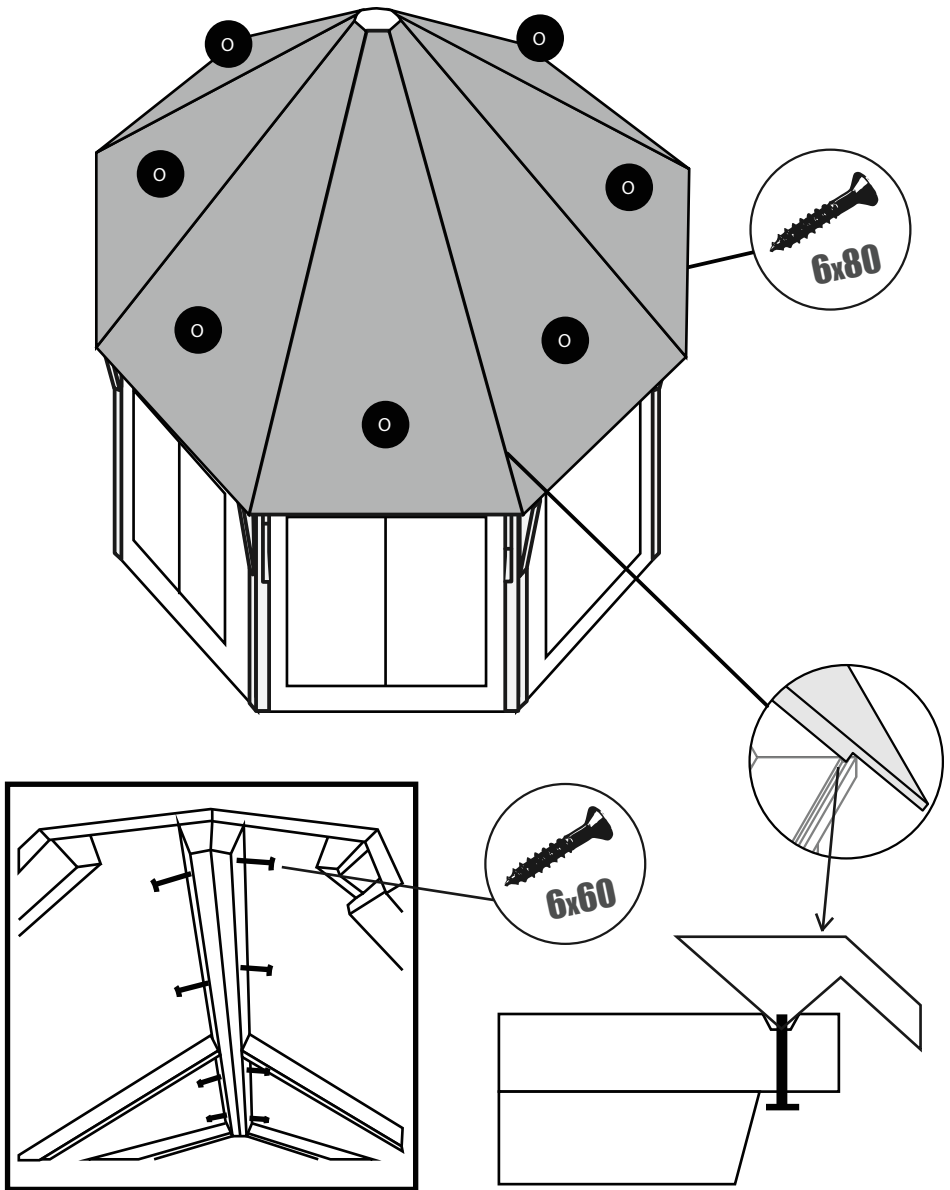

Be sure to provide support for each roof element while assembling. Use 8 screws to attach wall elements to one another and another 4 from under the brim planks.

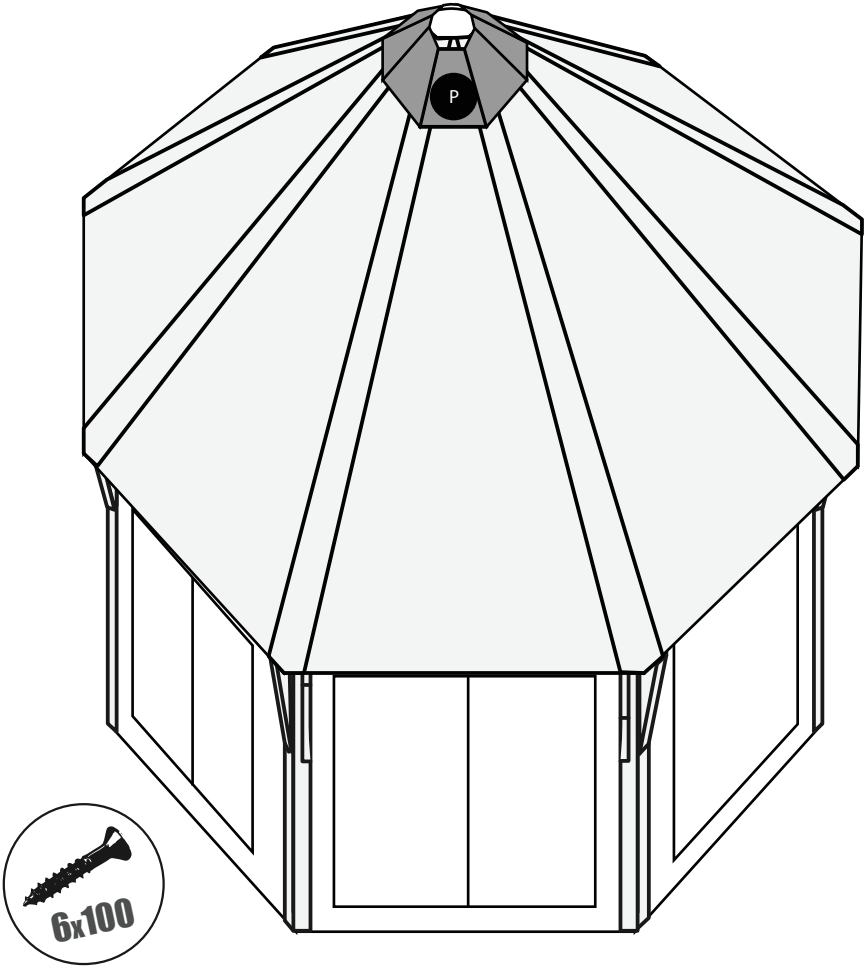

Attach the roof hat to the roof elements from below with 3 screws.

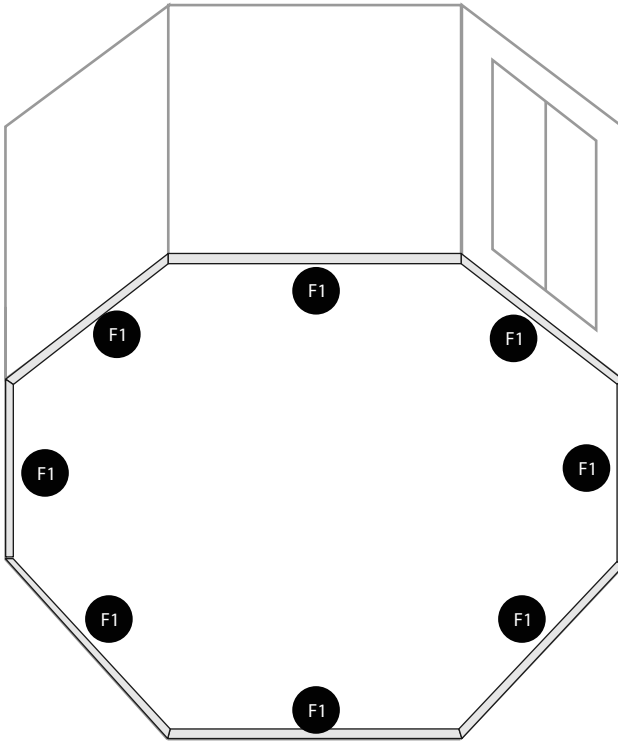

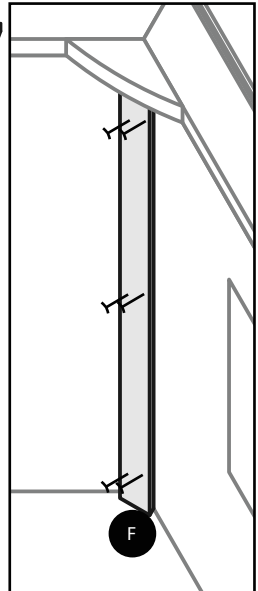
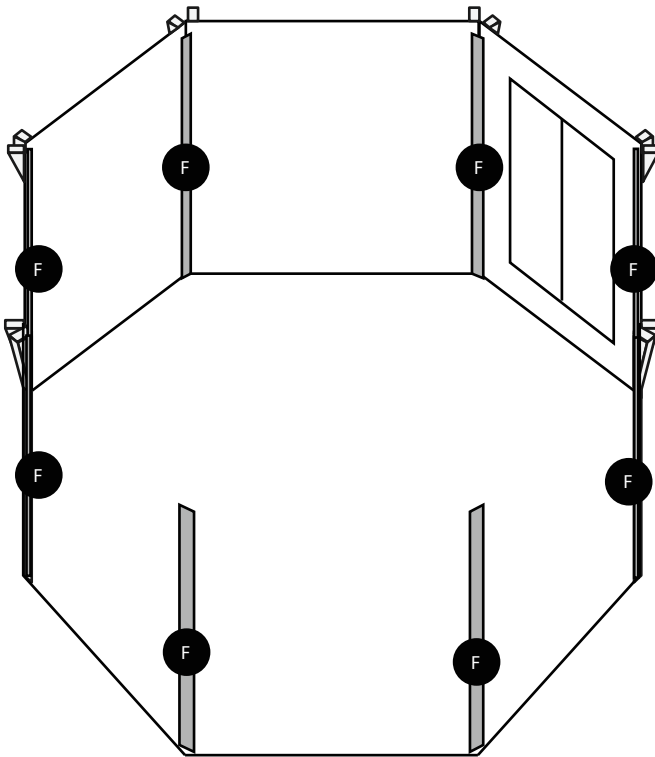

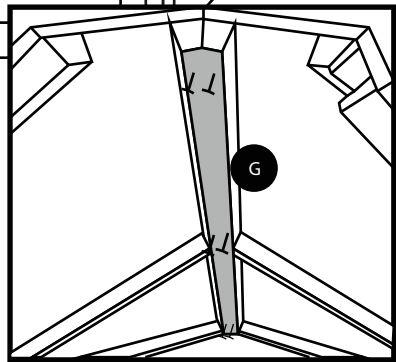
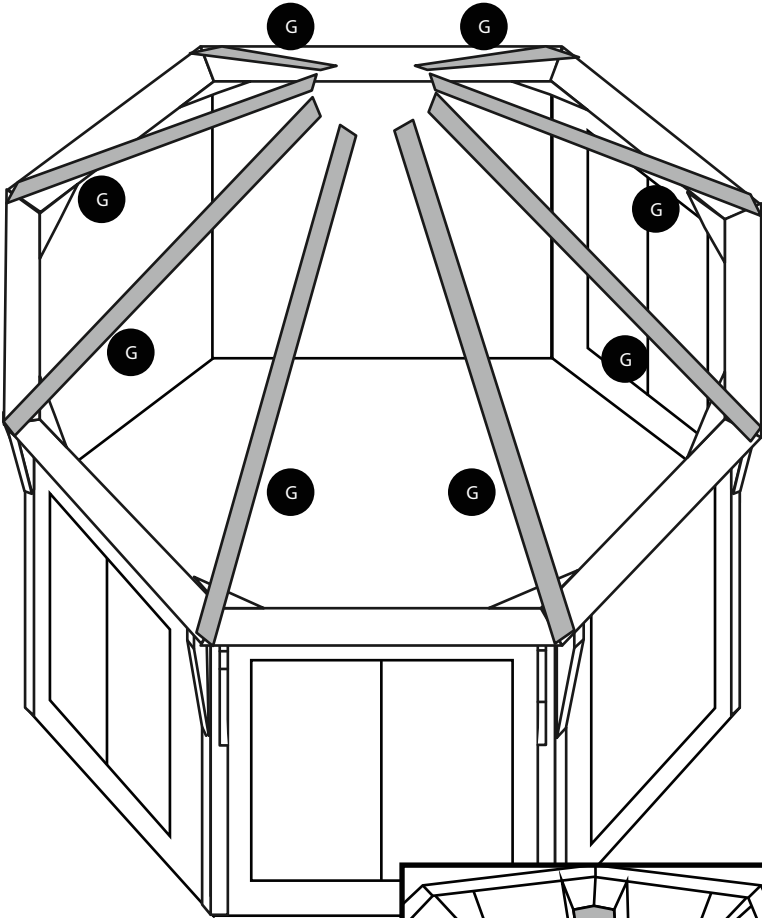

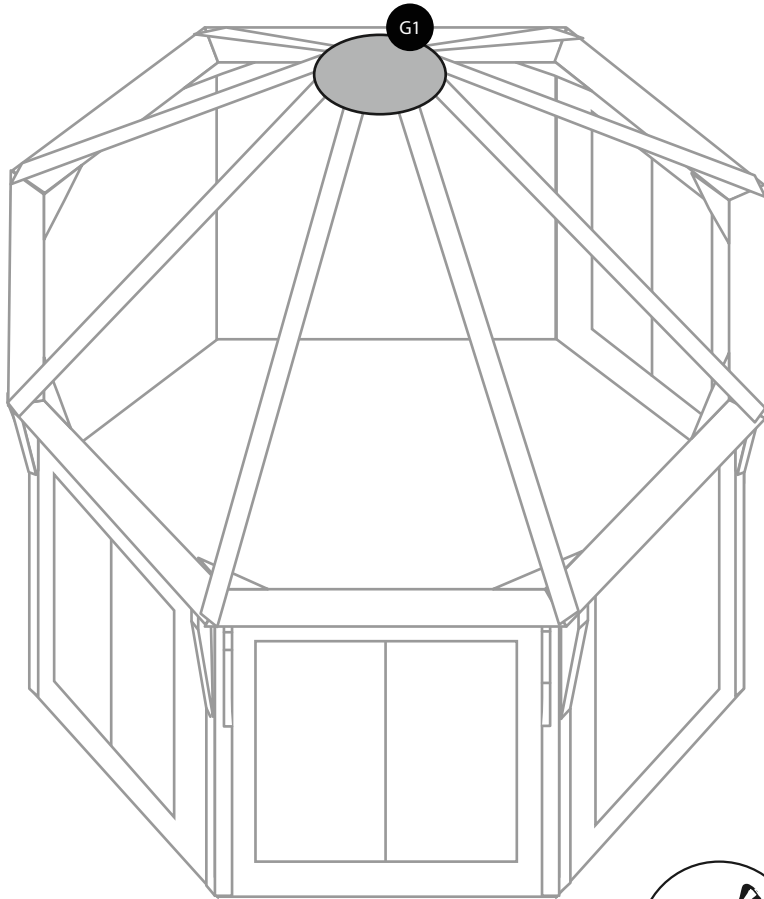

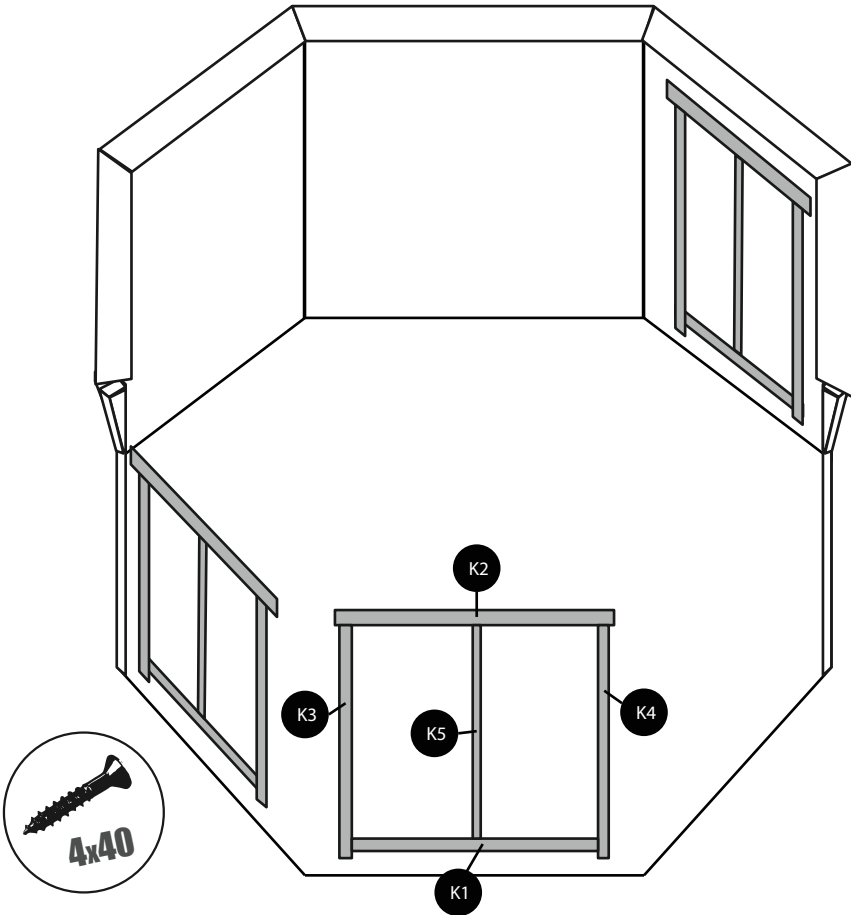

Attach the window strips inside the house. Strips are attached to the frame with ca 1.5cm overlay.