

Sonja 4

Bohlenaußenmaß (B x T): 300 x 320 cm

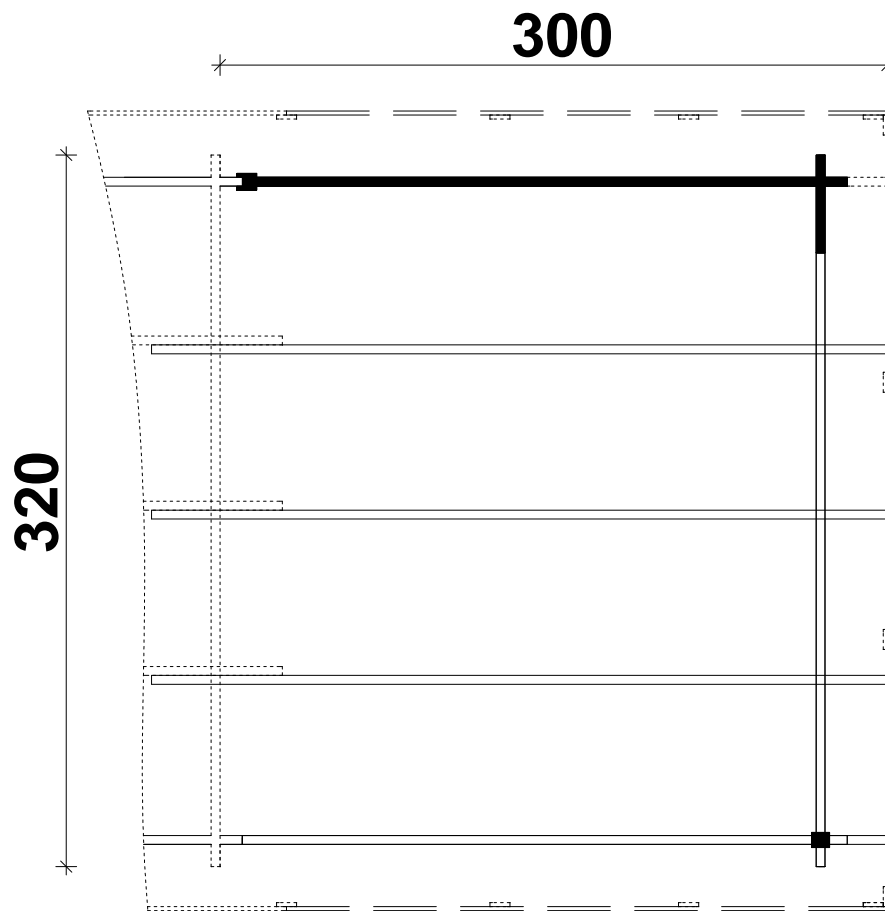









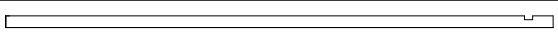







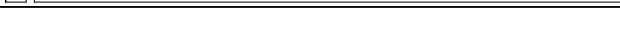

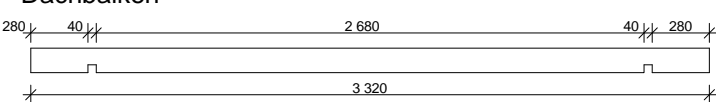
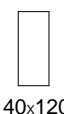
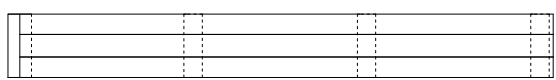
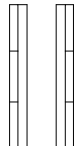
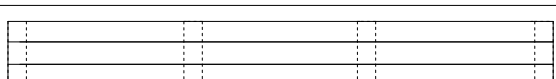
Bohlenstärke: 40 mm

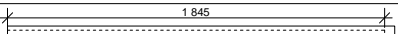

S Ø L U N D

Achtung : Alle angegebenen Maße sind ca. - Maße !

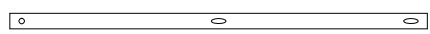
Sonja 4 - 40 mm

Nr	Beschreibung	Profil mm	Länge mm	Stück	
1	Fundamenthölzer	45x70	2720	1	
2			290	1	
3			2678	1	
4			2678	16	
5			4340	2	
6			440	17	
7			3200	1	
8			3200	1	
9				3020	2
10	Dachbalken 			3320	3
11	Blenden 			2720	2(1+1)
12	Blenden 	--		--	
13	Dachpappe		--	--	
14	Dachbretter	Lieferung entweder in Vers. 1 > oder in Vers. 2 >	 18x88	--	
			 18x110	3510	
15		45x70	280	4	
16	Dachpappe leisten	28x55	3000	1	
17	Pfosten 		70x90	1990	
18	Pfosten 		76x90	1910	
19	Regulierungsschraube 			1	
20	Sturmleisten 	20x40	2010	2	
21	Schrauben 4,0 x 40			1 Beutel	
22	Nägel 2,5 x 50			1 Beutel	
23	Dachpappnägel 3,0 x 15			--	
24	Schrauben 4,5 x 70			1 Beutel	
25	Schloßschrauben M 8 x 70, Mutter, U-Scheibe			6	
26		40x143	280	3	
27	Brett	18x90	210	1	
28			2365	1	
29	Schlaghölzer		300-400		

Sonja 4 - 40 mm

Wand A

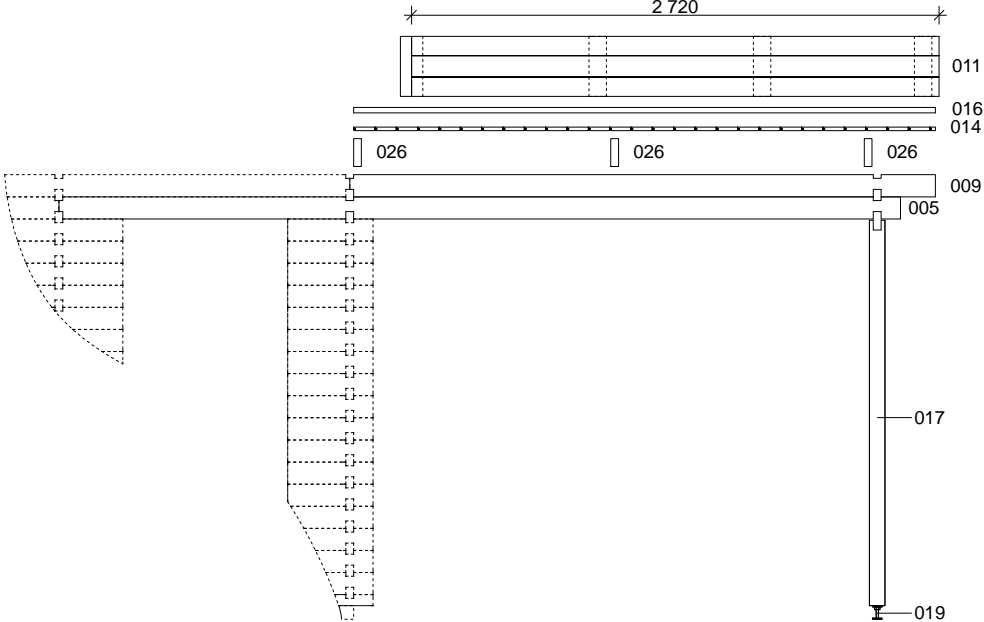

Wand B

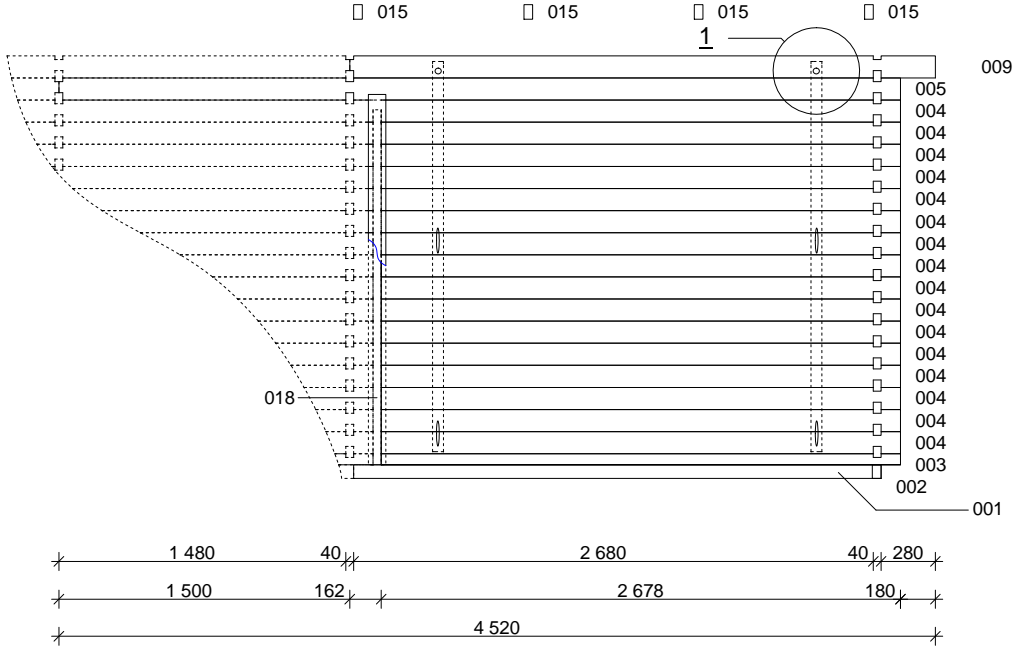

Sonja 4 - 40 mm

Wand C

