

Brantevik I 40 (360x300)

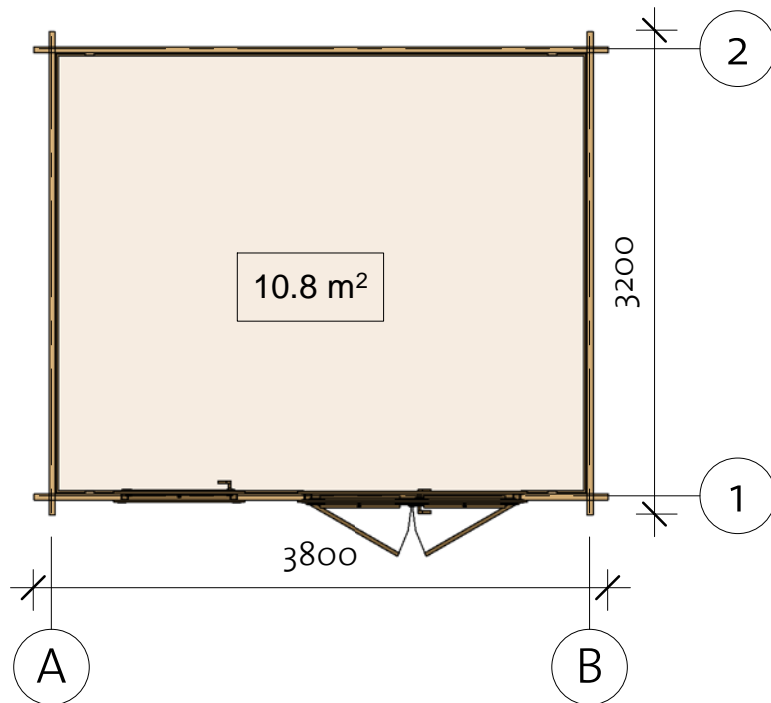

Brantevik I 40 (360x300)

Foundation

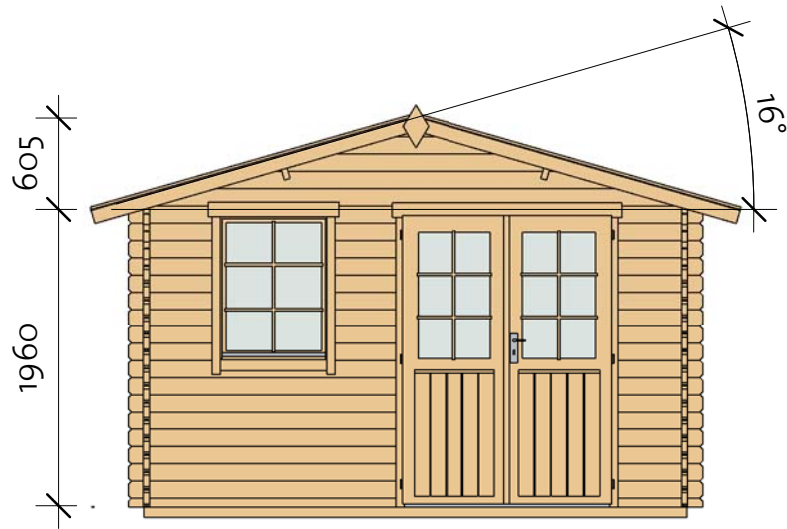
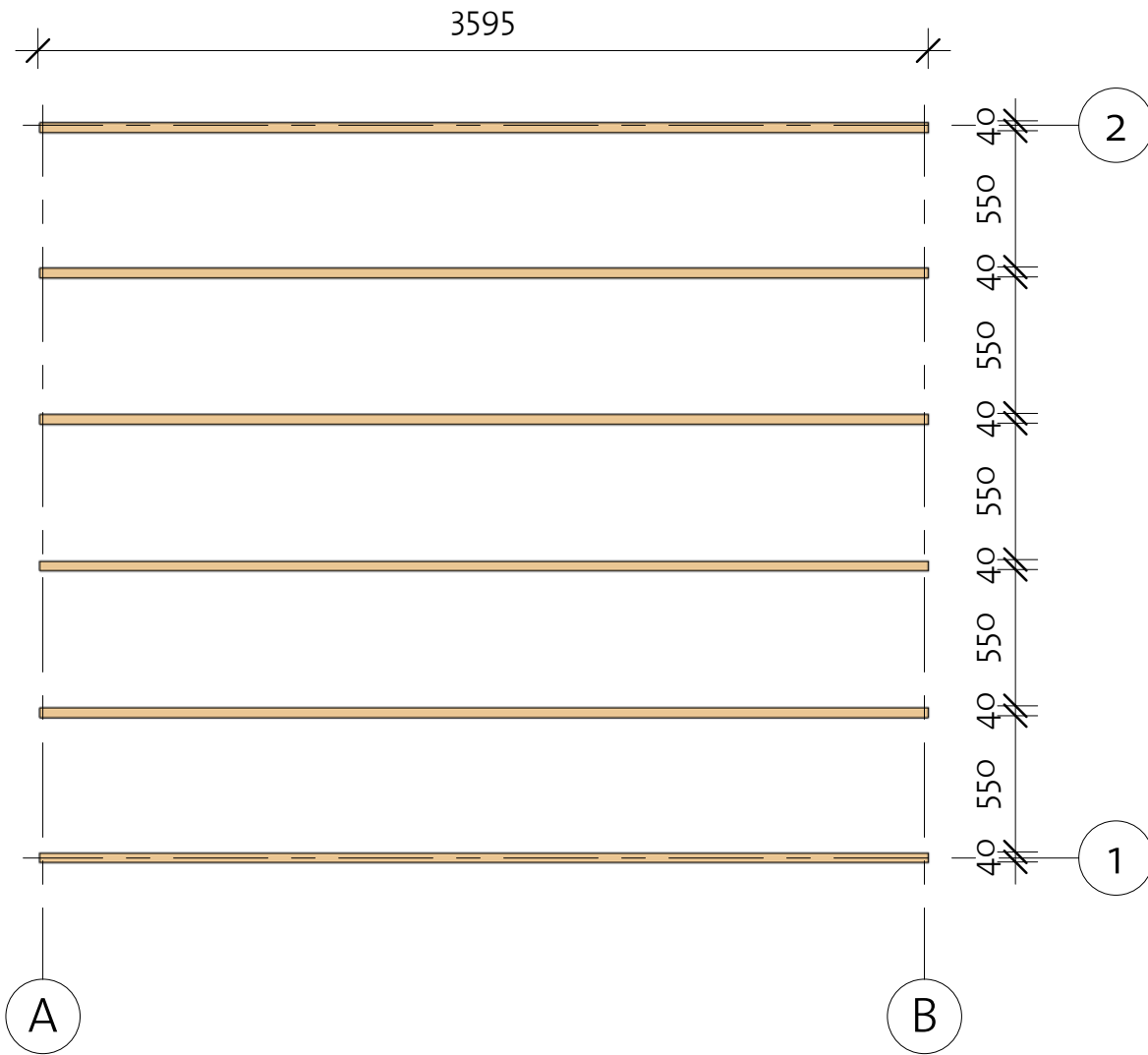

Impregnated foundation beams				
Mark	Type	Profile	Count	Length

IFB	IFB 40x70		6	3590
-----	--------------	---	---	------



Brantevik I 40 (360x300)

Floor Plan

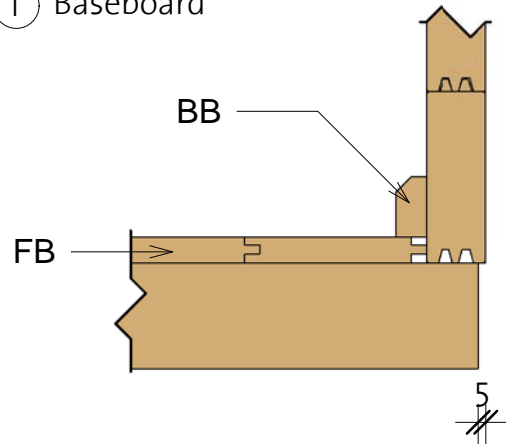
① Baseboard



Floor Schedule

Mark	Type	Profile	Count	Length
FB	FB 18x110		33	2915
BB1	BB 20x40		2	3600
BB2	BB 20x40		2	3000

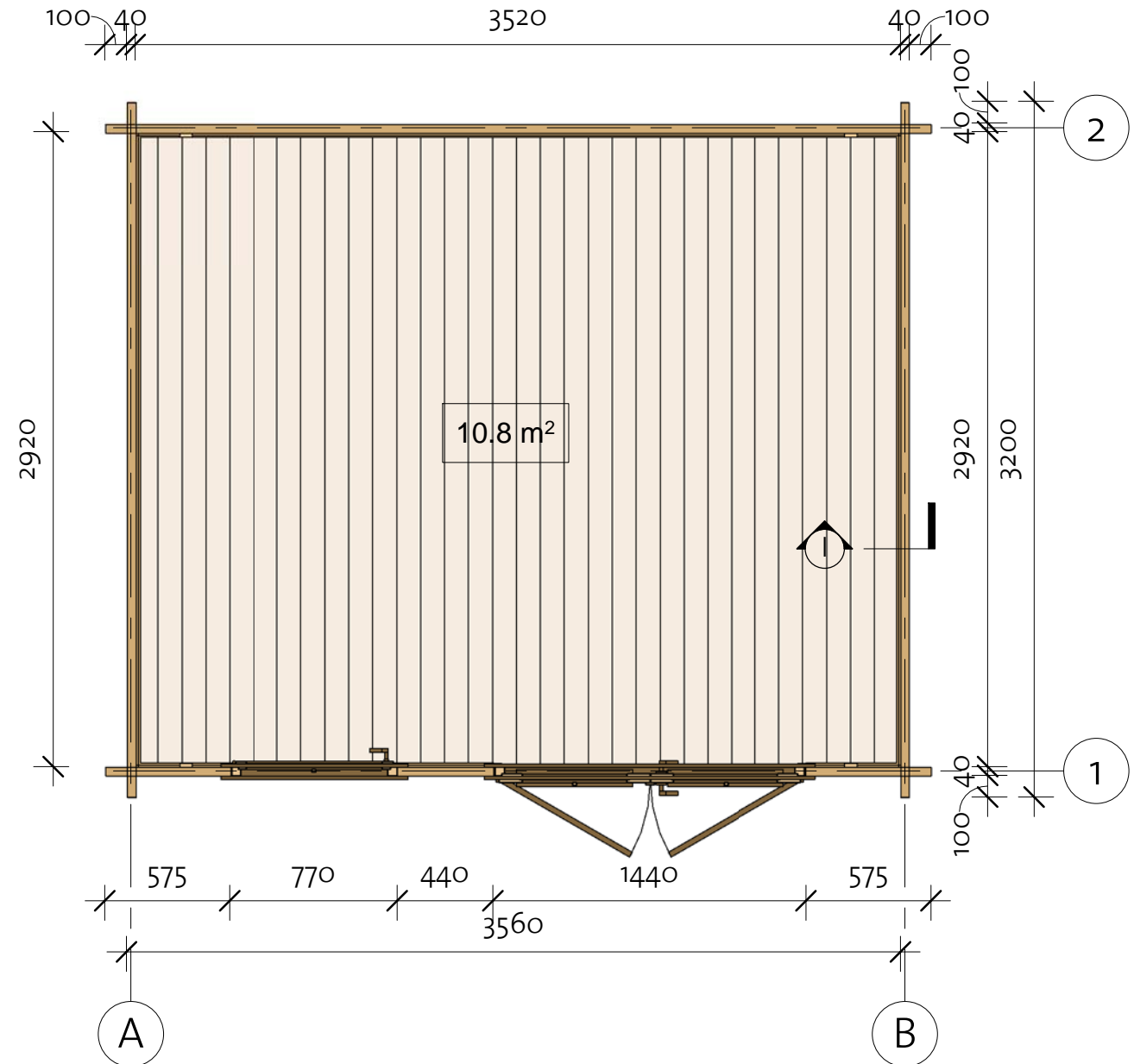

4200003_190222

Brantevik I 40 (360x300)

Wall 1

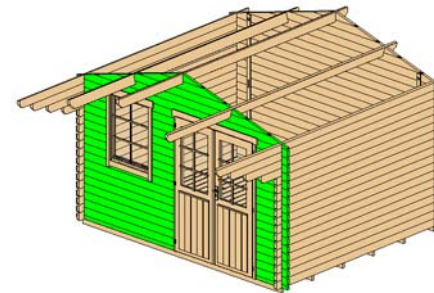

Wall 1

Mark	Profile	Count	Cut Length
------	---------	-------	------------

1BL 1	40x57	1	575
1BL 2	40x57	1	1785
1LG 1	40x114	9	440
1LG 2	40x114	26	575
1LG 3*	40x114	1	791
1LG 4*	40x114	1	1583
1LG 5	40x114	8	1785
1LG 6*	40x114	1	2374
1LG 7*	40x114	1	3166
1LG 8*	40x114	1	3800

*Gable-delivered premounted

Log Profile Wall 1

Profile	Profile
---------	---------

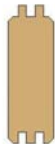
40x57	
40x114	

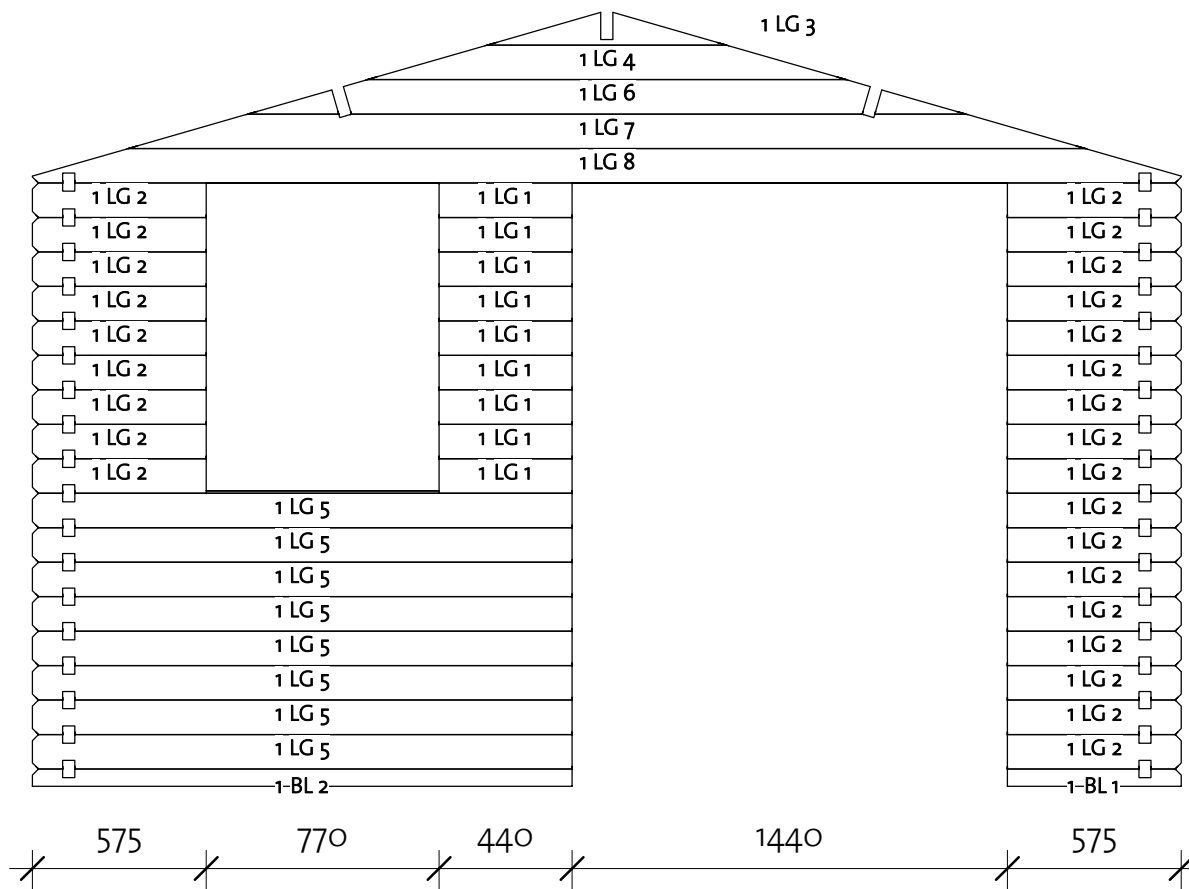

Brantevik I 40 (360x300)

Wall 2

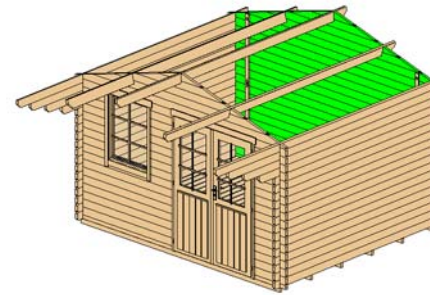

Wall 2			
Mark	Profile	Count	Cut Length

2BL 1	40x57	1	3800
2LG 1 *	40x114	1	791
2LG 2 *	40x114	1	1583
2LG 3 *	40x114	1	2374
2LG 4 *	40x114	1	3166
2LG 5 *	40x114	1	3800
2LG 6	40x114	17	3800

*Gable-delivered premounted

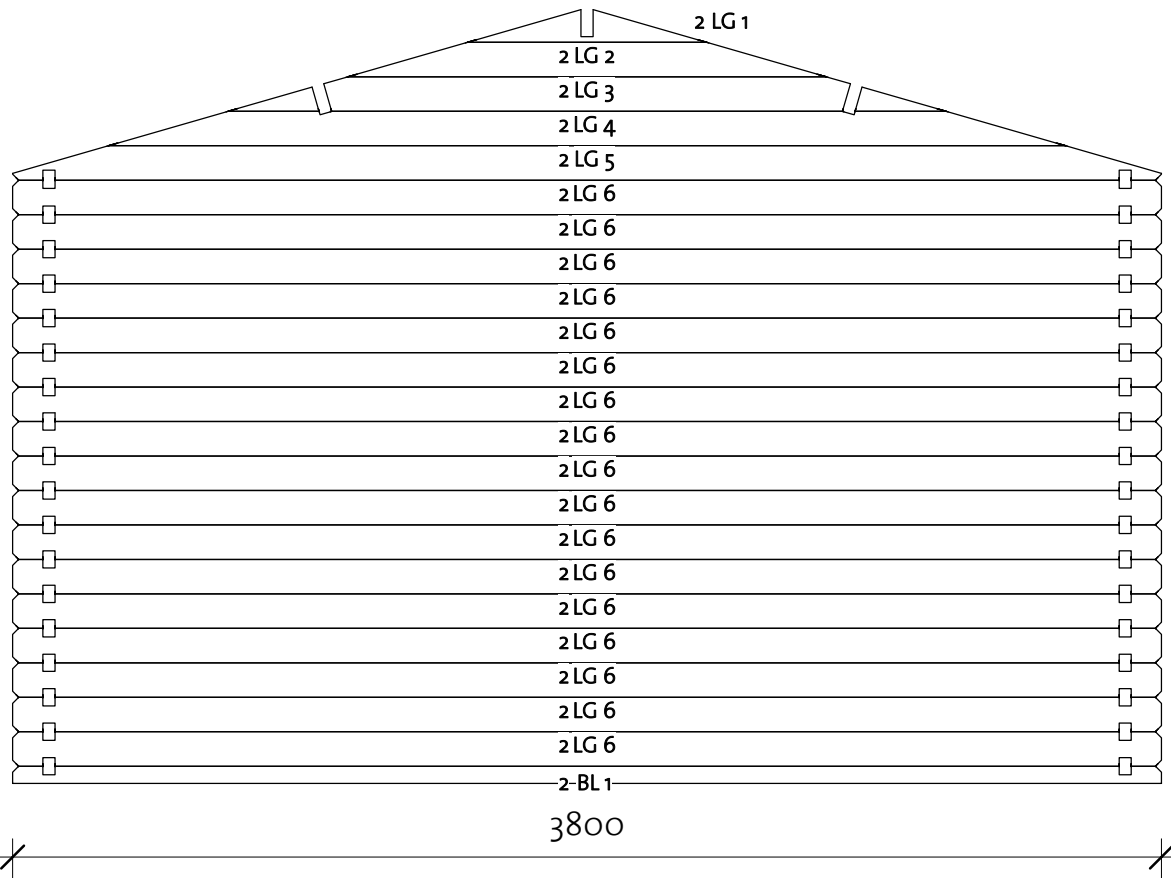

Log Profile Wall 2	
Profile	Profile

40x57	
40x114	

Brantevik I 40 (360x300)

Wall A

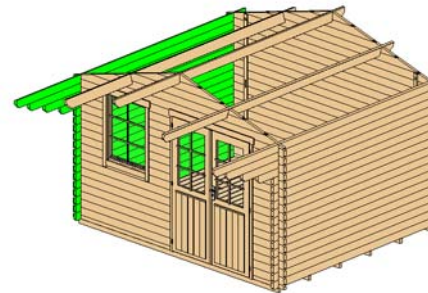

Wall A			
Mark	Profile	Count	Cut Length

ALG 1	40x114	14	3200
ALG 2	40x114	1	3500
ALG 3	40x114	1	3800
ALG 4	40x114	1	4100
ATL 1	40x120	1	4450

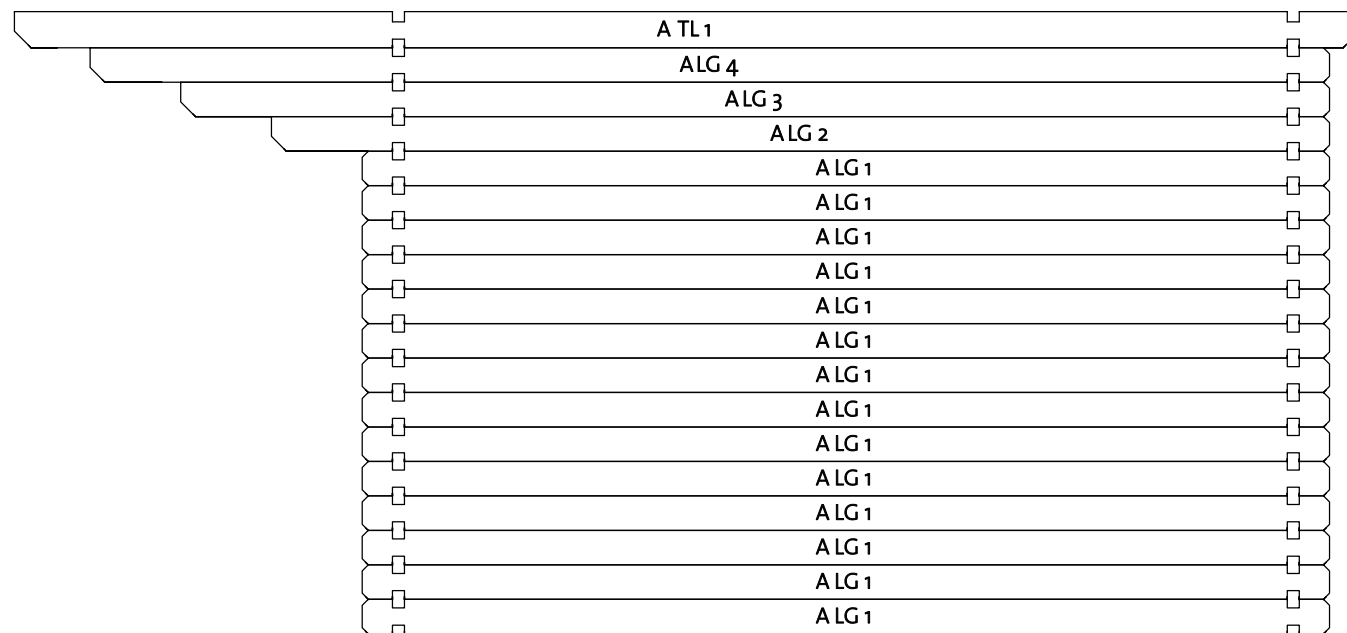

Log Profile Wall A	
Profile	Profile

40x114	
40x120	

Brantevik I 40 (360x300)

Wall B

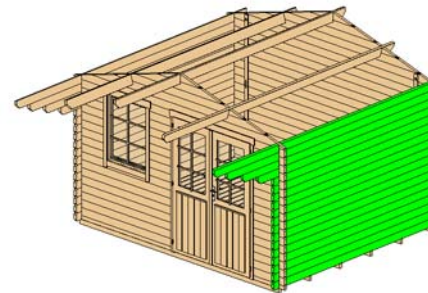

Wall B			
Mark	Profile	Count	Cut Length

BLG 1	40x114	14	3200
BLG 2	40x114	1	3500
BLG 3	40x114	1	3800
BLG 4	40x114	1	4100
BTL 1	40x120	1	4450

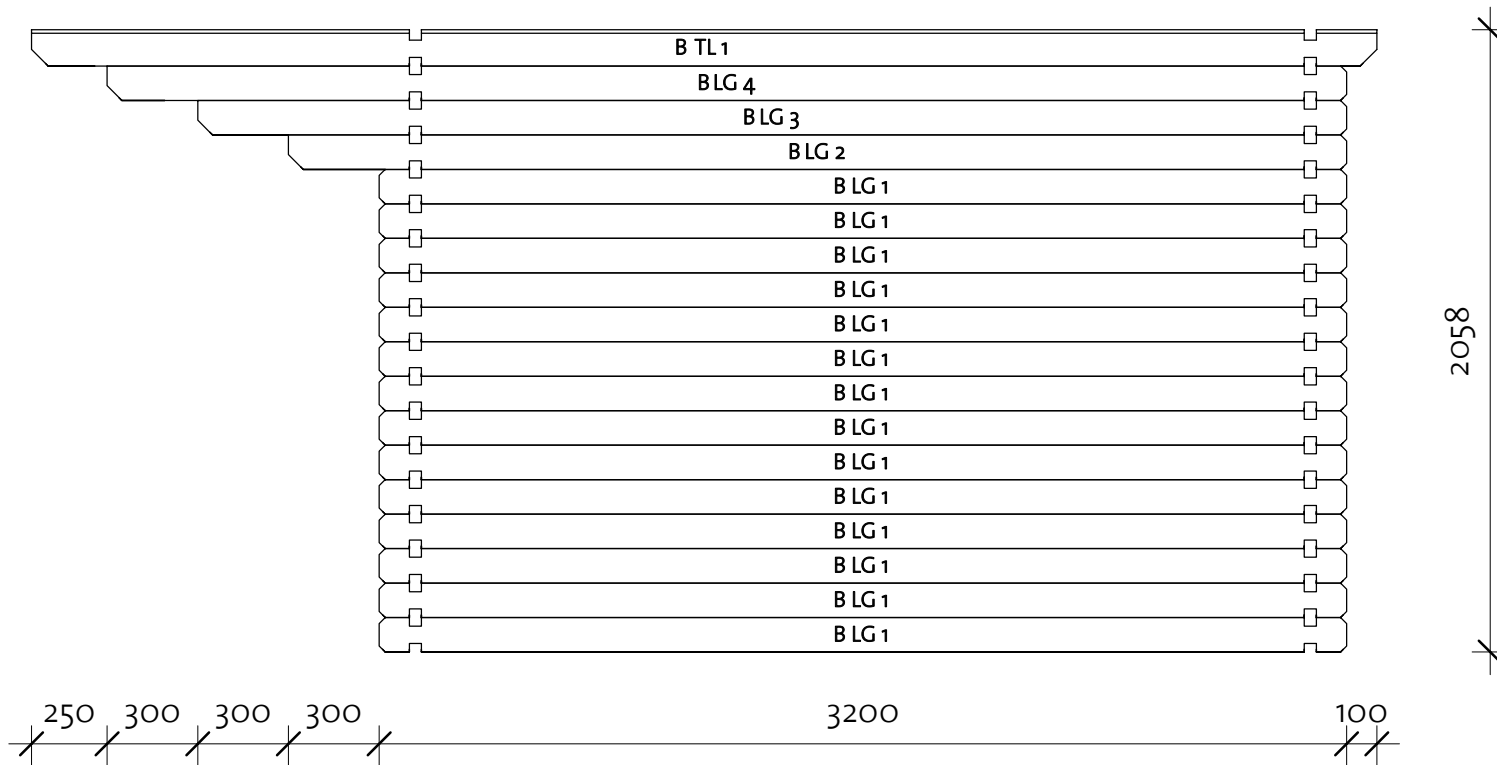





Log Profile Wall B	
Profile	Profile

40x114	
40x120	

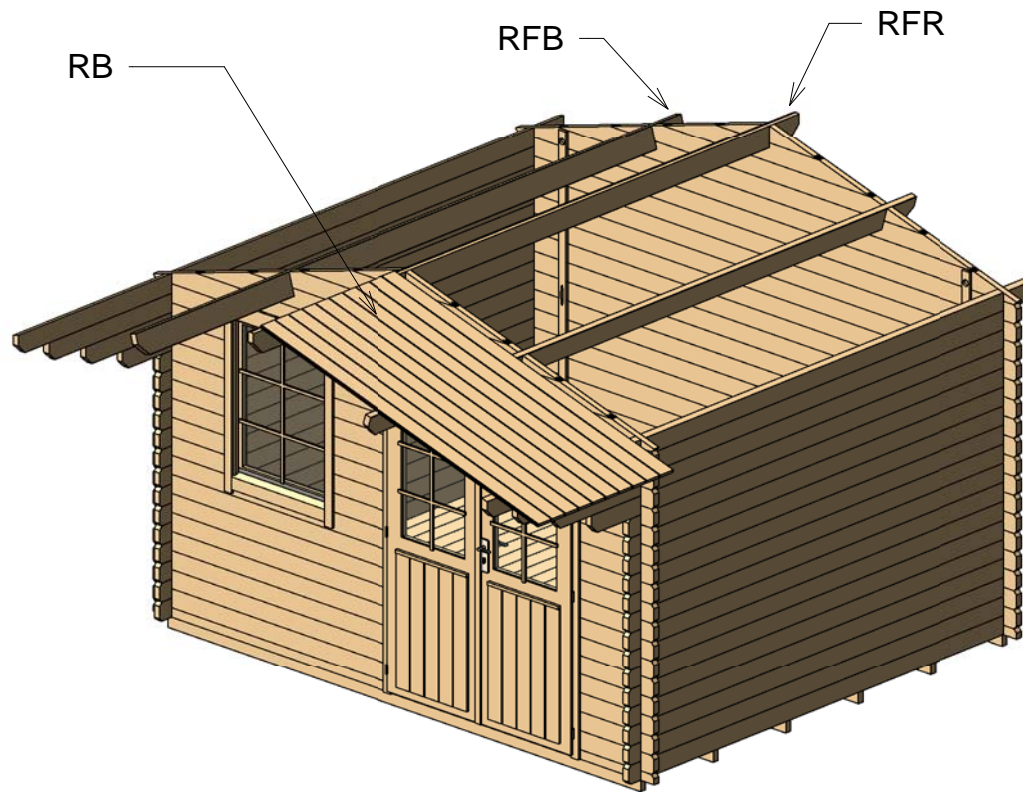
Brantevik I 40 (360x300)

Roof 1



Roof				
Mark	Type	Profile	Count	Length
RFR	Ridge 40x143		1	4450
RFB	Beam 40x143		2	4450
RB	Roofboard 18x110		84	2195

Brantevik I 40 (360x300)

Roof 2

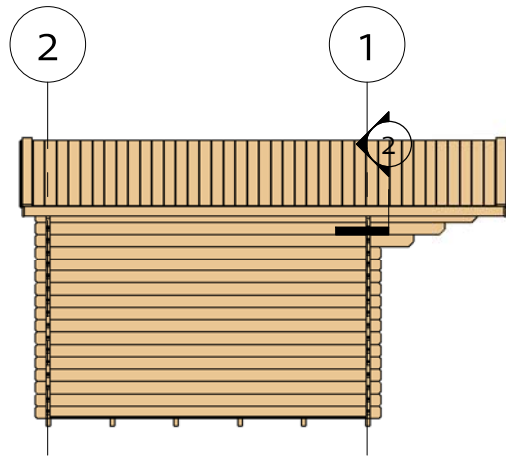

② Facia

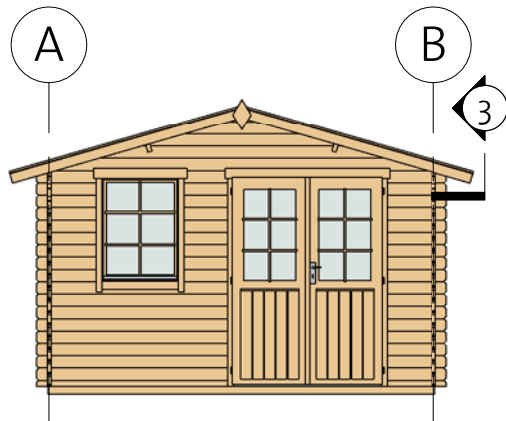
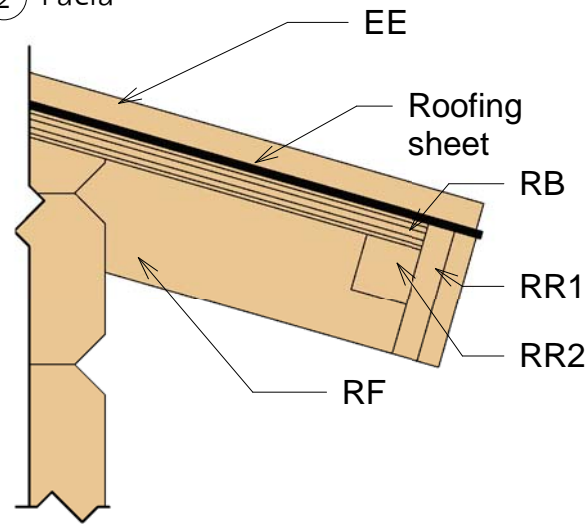

③ Roof Reinforcement

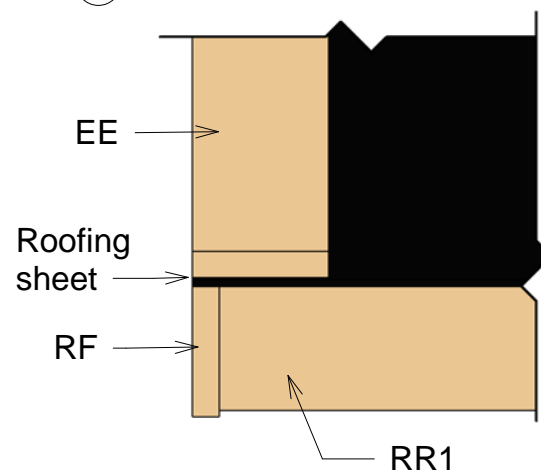

Fascia Schedule				
Mark	Type	Profile	Count	Length
EE	Eave Edging 18x90		4	2233
RF	Roof Fascia 18x90		4	2233
RR1	Roof reinforcement 18x90		2	4450
RR2	Roof reinforcement 38x38		2	4450

Brantevik I 40 (360x300)

Extras

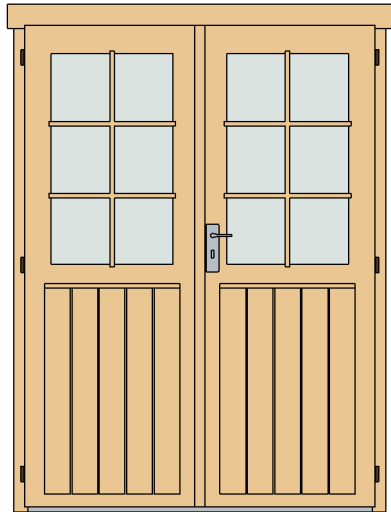

Door Schedule				
Model	Type	Width	Height	Count
CDD1R	Classic double door 1 right	1425	1955	1
DCB6	Door crossbar 6	--	--	2

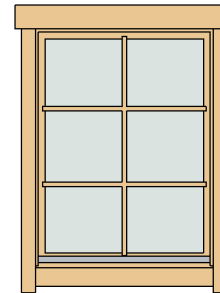

Window Schedule				
Model	Type	Width	Height	Count
CW1R	Classic window 1 right	765	990	1
WCB6	Window crossbar 6	--	--	1

Fasteners & Extras		
Name	Type	Count

Hitblock	300-400 mm	
Screws	5,0 x 70	10
Bolts	M8 x 70	12
Screws	6,0 x 140	30
Nails	1,4 x 40	30
Screws	4,0 x 40	70
Screws	4,0 x 50	480



Type	Count	Lenght
Windboard 18x40	4	2010



Family	Count
Romb	2

4200003_190227

Brantevik I 40 (360x300)

List of all items 1

Impregnated foundation beams

Mark	Type	Profile	Count	Length
------	------	---------	-------	--------

IFB	IFB 40x70		6	3590
-----	--------------	---	---	------

Floor Schedule

Mark	Type	Profile	Count	Length
------	------	---------	-------	--------

FB	FB 18x110		33	2915
----	-----------	---	----	------

BB1	BB 20x40		2	3600
-----	-------------	---	---	------

BB2	BB 20x40		2	3000
-----	-------------	--	---	------

Roof

Mark	Type	Profile	Count	Length
------	------	---------	-------	--------

RFR	Ridge 40x143		1	4450
-----	-----------------	---	---	------

RFB	Beam 40x143		2	4450
-----	----------------	---	---	------

RB	Roofboard 18x110		84	2195
----	---------------------	---	----	------

Fascia Schedule

Mark	Type	Profile	Count	Length
------	------	---------	-------	--------

EE	Eave Edging 18x90		4	2233
----	----------------------	---	---	------

RF	Roof Fascia 18x90		4	2233
----	----------------------	---	---	------

RR1	Roof reinforcement 18x90		2	4450
-----	--------------------------------	---	---	------

RR2	Roof reinforcement 38x38		2	4450
-----	--------------------------------	---	---	------

Brantevik I 40 (360x300)

List of all items 2

Wall 1			
Mark	Profile	Count	Cut Length

1BL 1	40x57	1	575
1BL 2	40x57	1	1785
1LG 1	40x114	9	440
1LG 2	40x114	26	575
1LG 3*	40x114	1	791
1LG 4*	40x114	1	1583
1LG 5	40x114	8	1785
1LG 6*	40x114	1	2374
1LG 7*	40x114	1	3166
1LG 8*	40x114	1	3800

Wall 2			
Mark	Profile	Count	Cut Length

2BL 1	40x57	1	3800
2LG 1*	40x114	1	791
2LG 2*	40x114	1	1583
2LG 3*	40x114	1	2374
2LG 4*	40x114	1	3166
2LG 5*	40x114	1	3800
2LG 6	40x114	17	3800

*Gable-delivered premounted



Wall A			
Mark	Profile	Count	Cut Length

ALG 1	40x114	14	3200
ALG 2	40x114	1	3500
ALG 3	40x114	1	3800
ALG 4	40x114	1	4100
ATL 1	40x120	1	4450

Wall B			
Mark	Profile	Count	Cut Length

BLG 1	40x114	14	3200
BLG 2	40x114	1	3500
BLG 3	40x114	1	3800
BLG 4	40x114	1	4100
BTL 1	40x120	1	4450

Log Profiles	
Profile	Profile

40x57	
40x114	

Log Profiles	
Profile	Profile

40x120	
--------	---