

# MARY 1

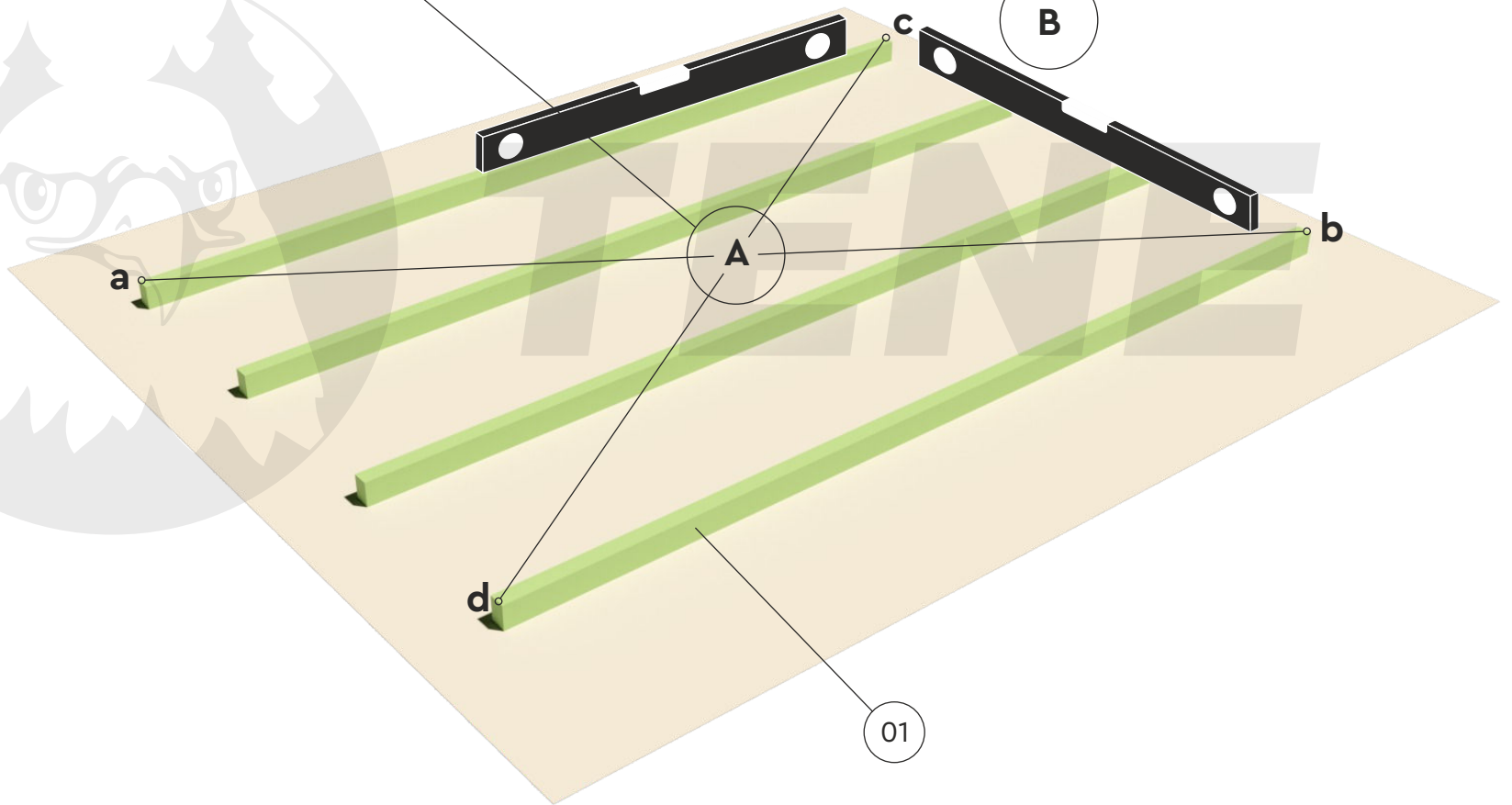

# MARY 1

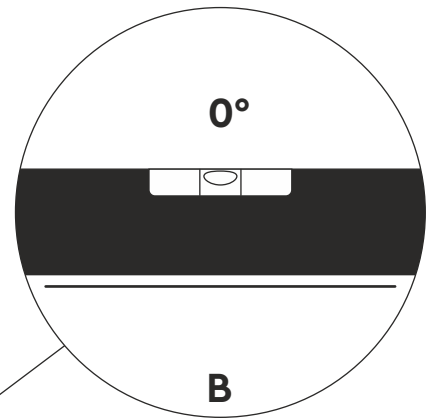
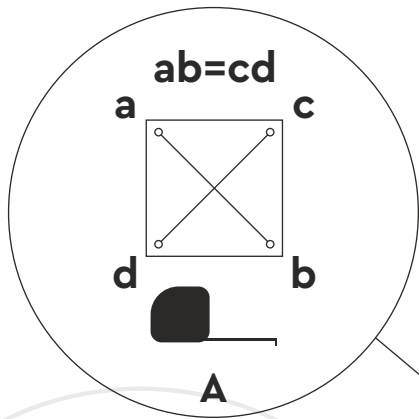
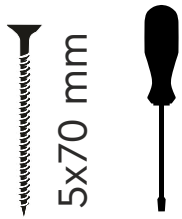
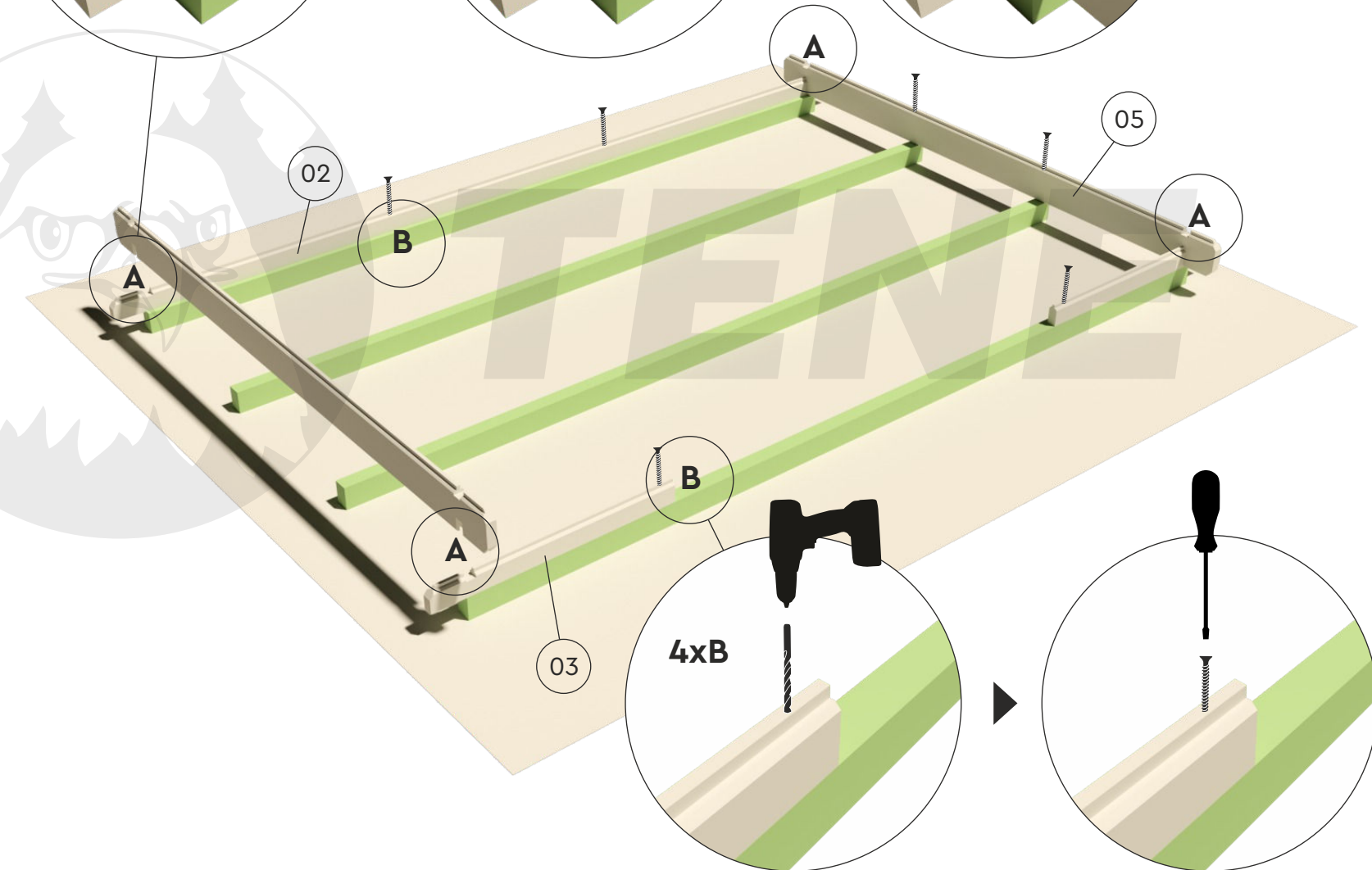
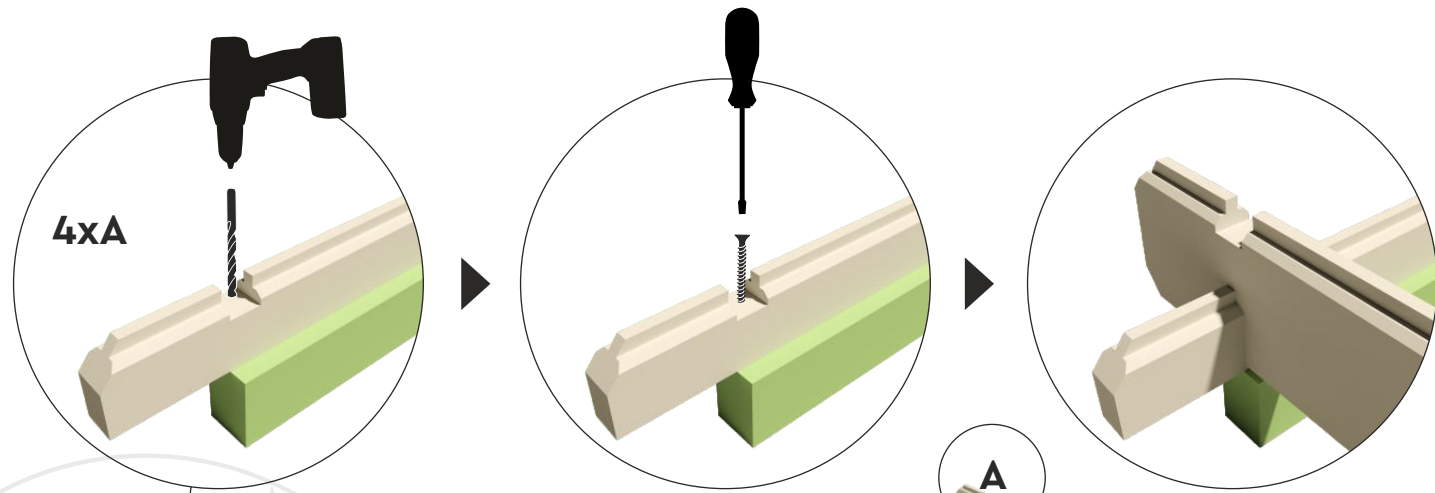

# MARY 1

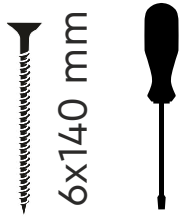
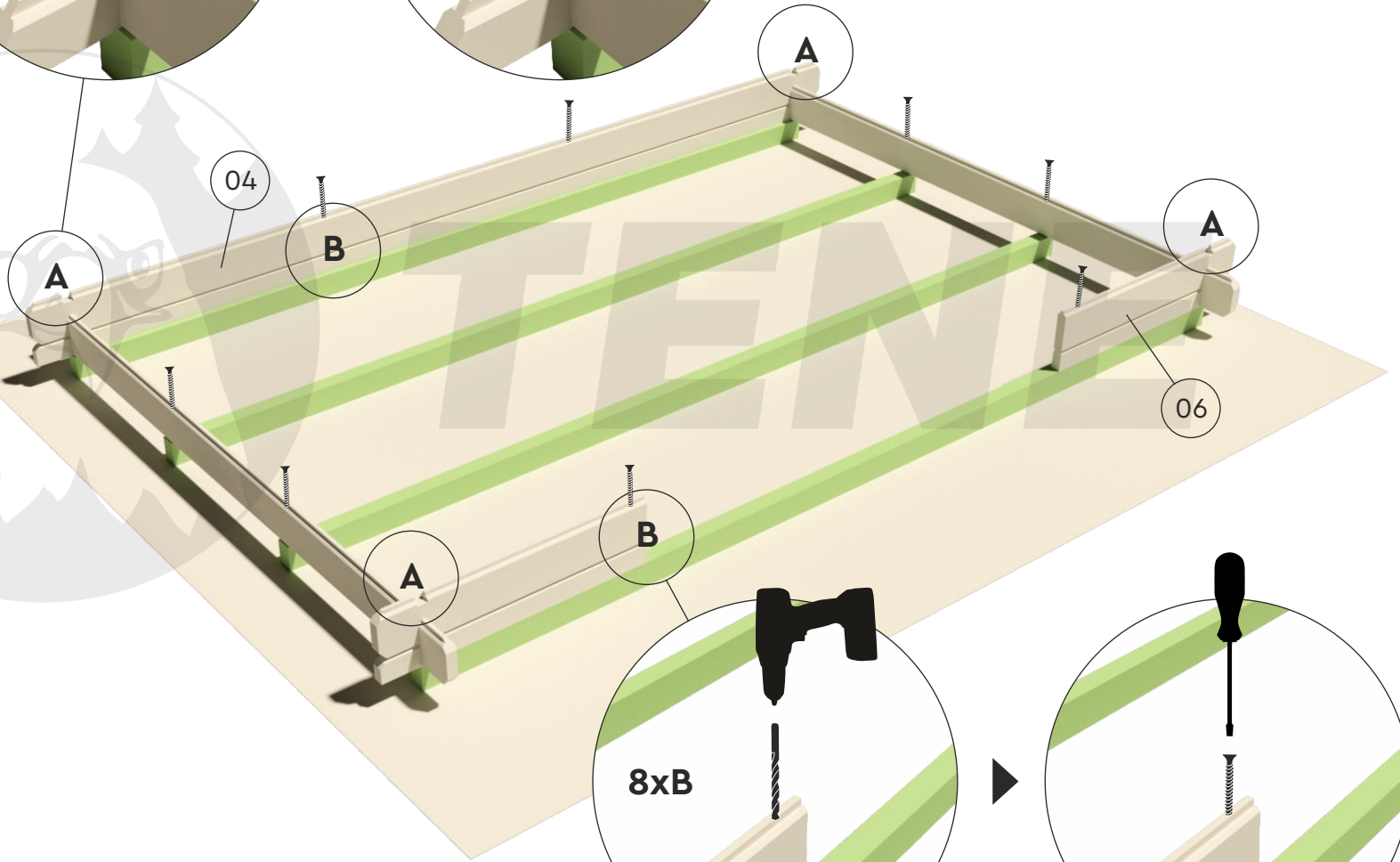
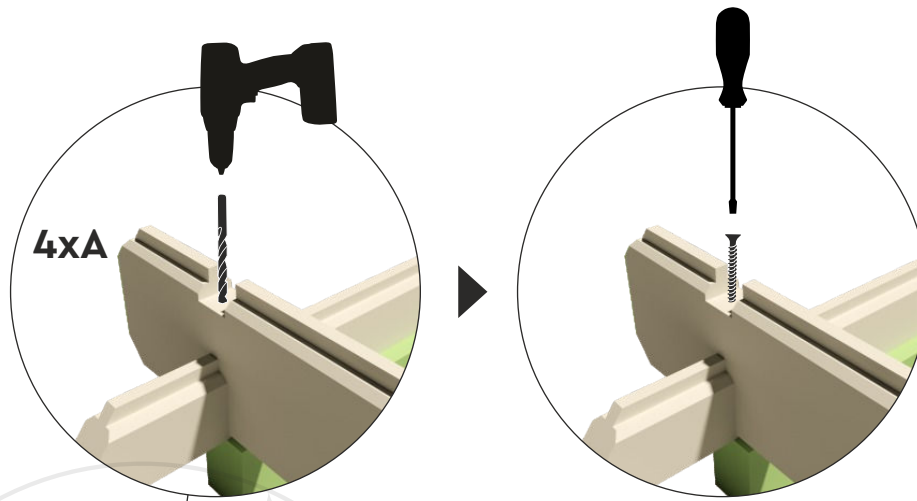

# MARY 1

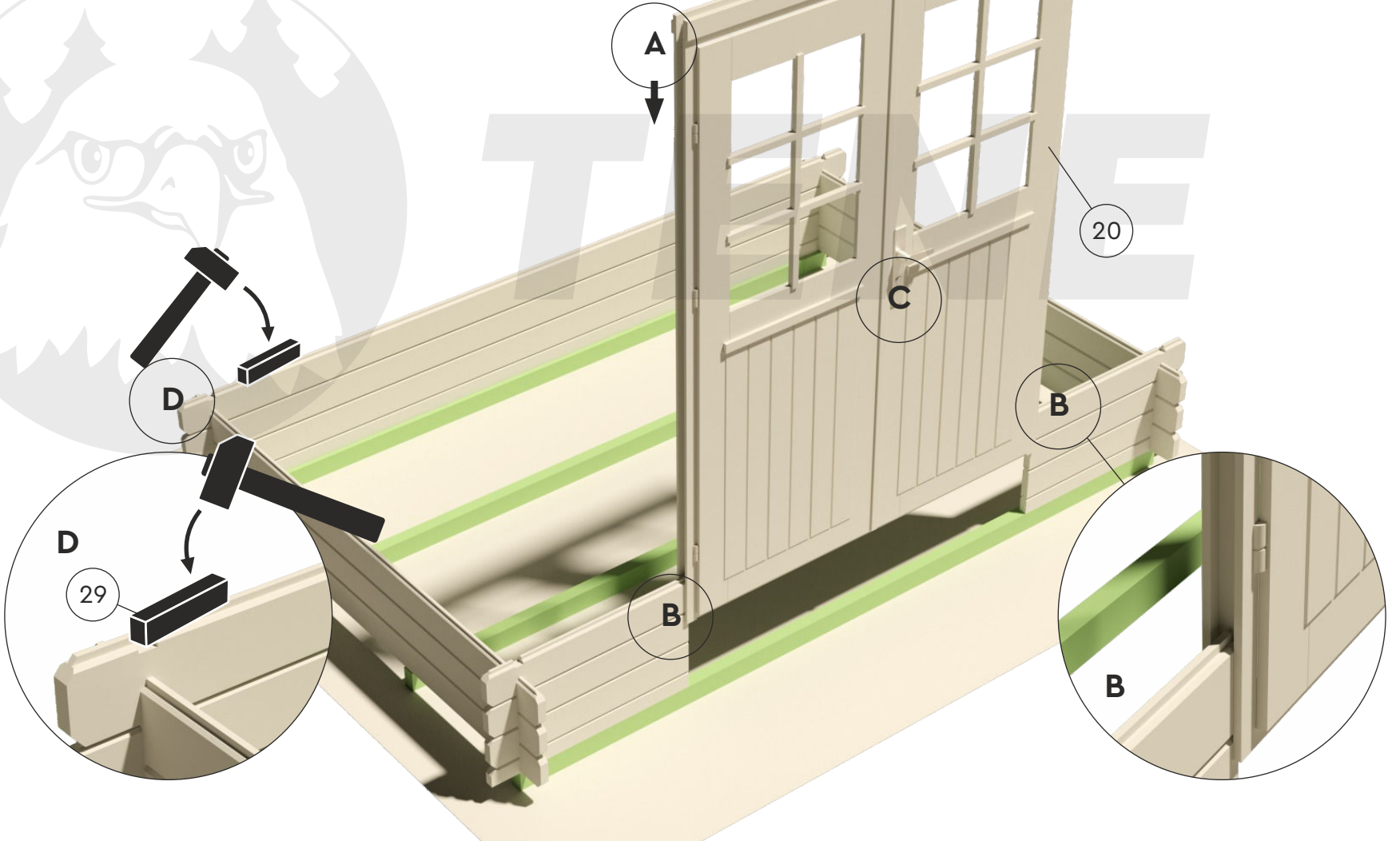
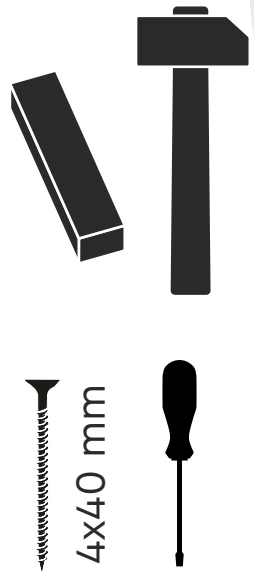
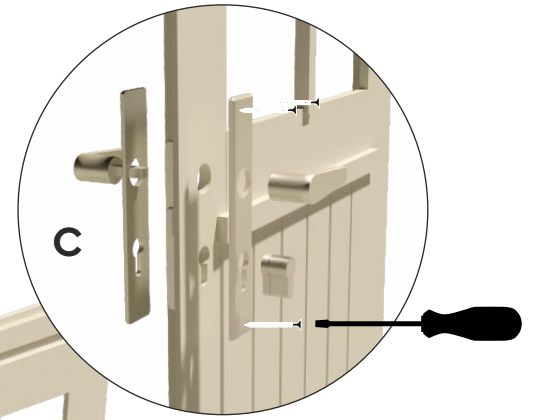
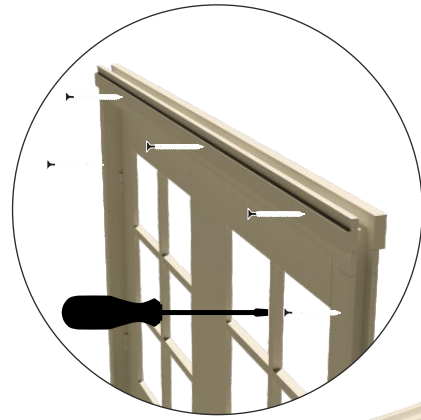
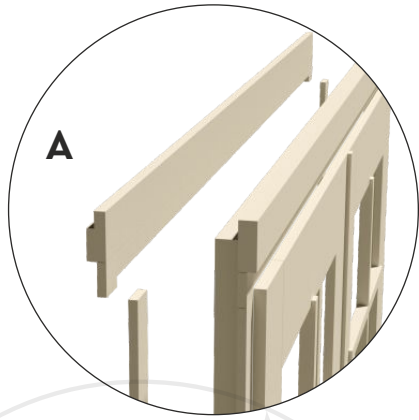

# MARY 1

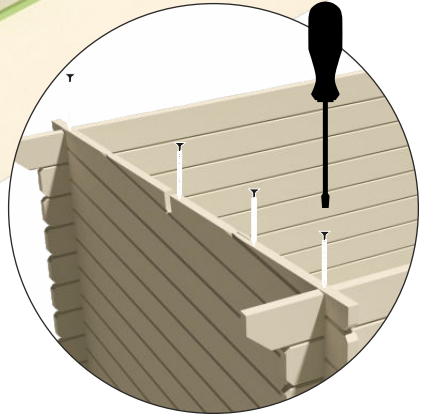
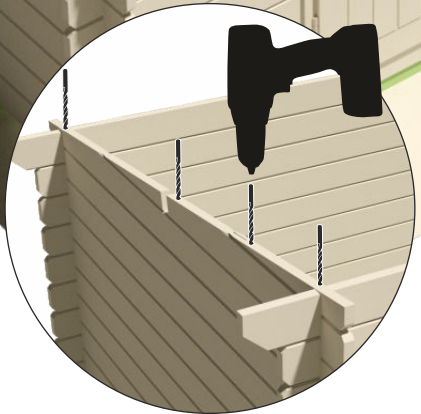
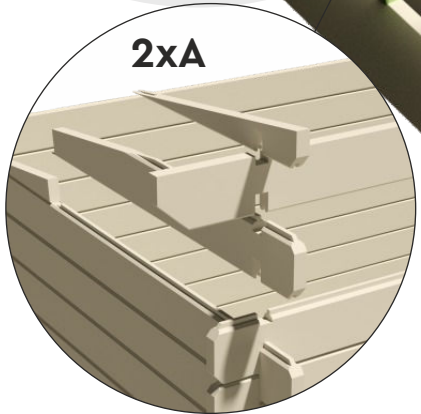
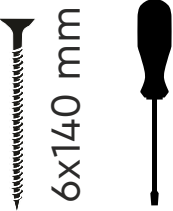
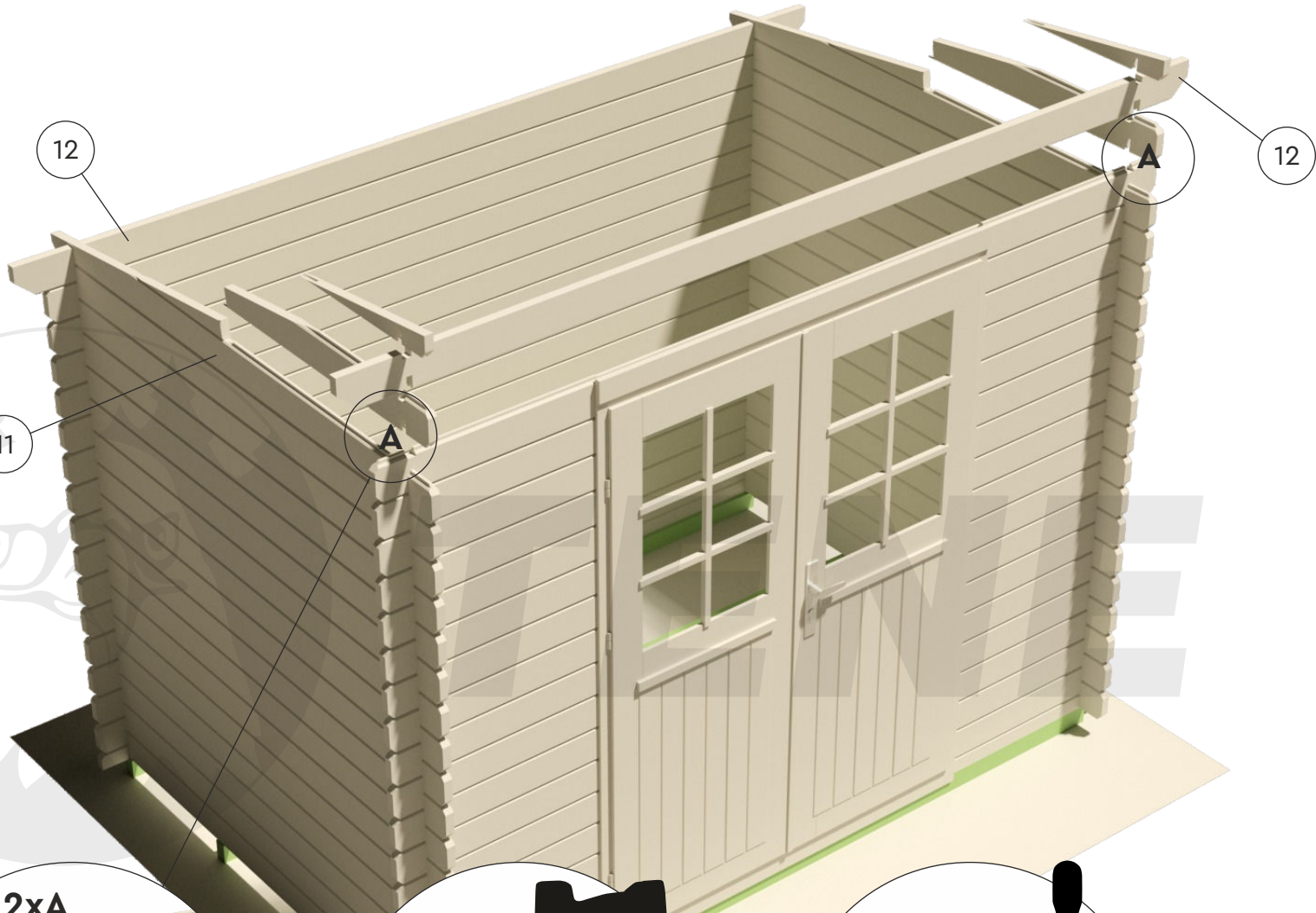

# MARY 1

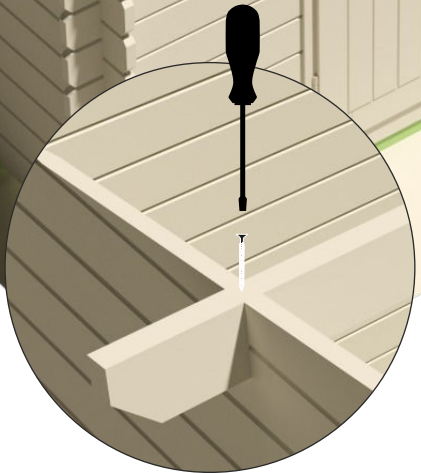
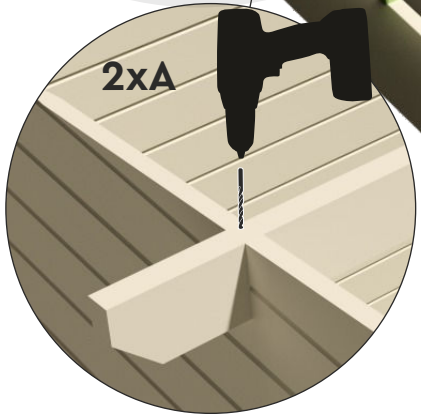
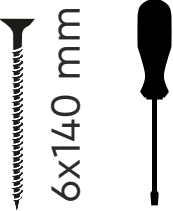
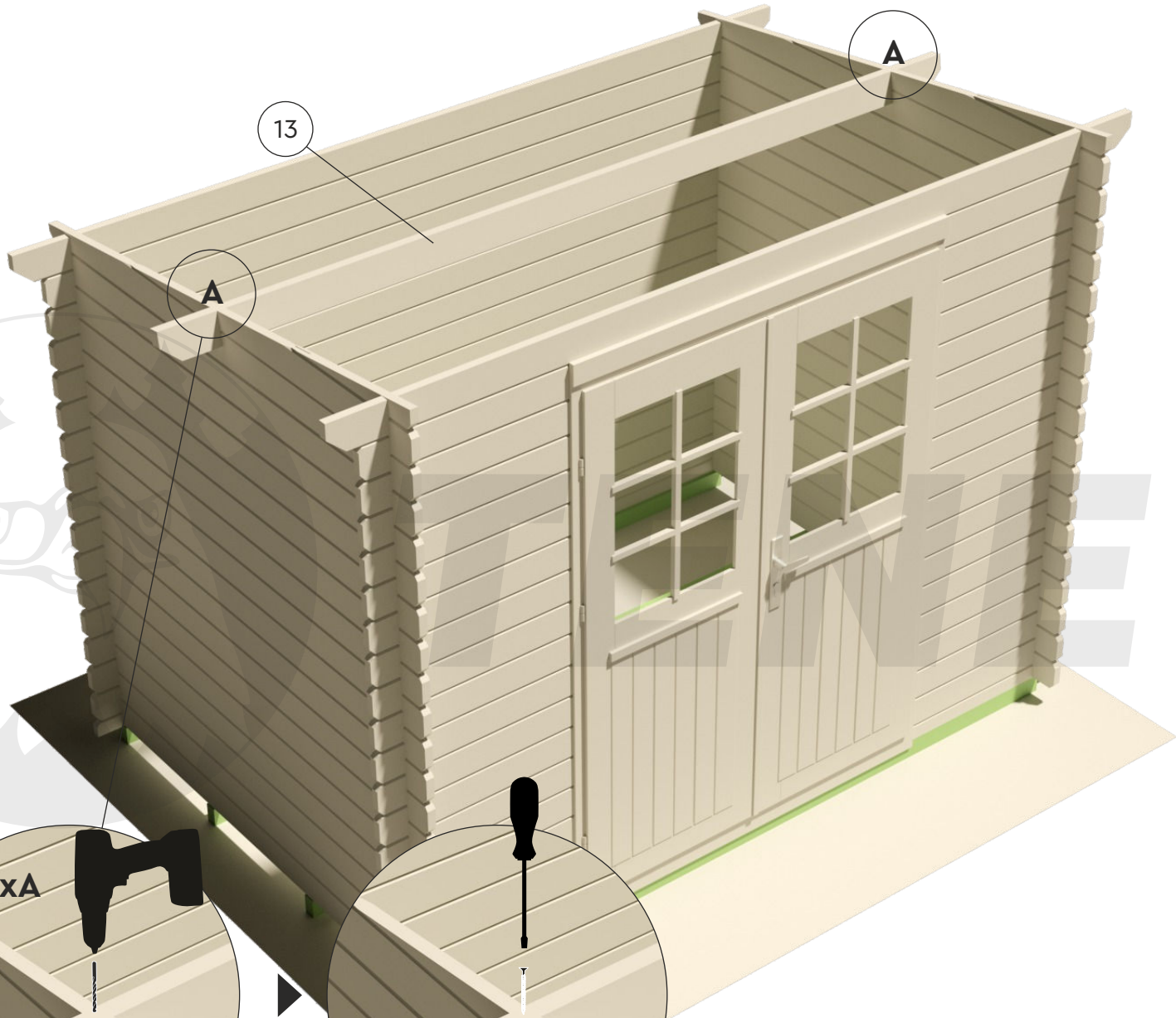

# MARY 1

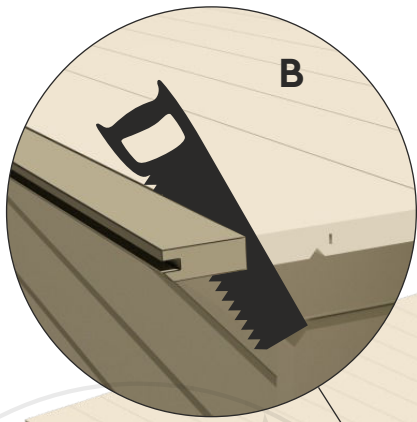

17

A

B

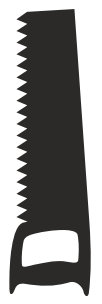
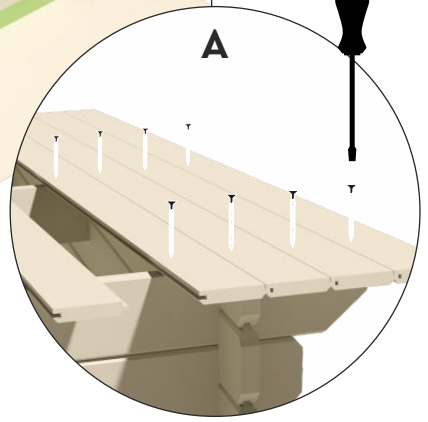



# MARY 1

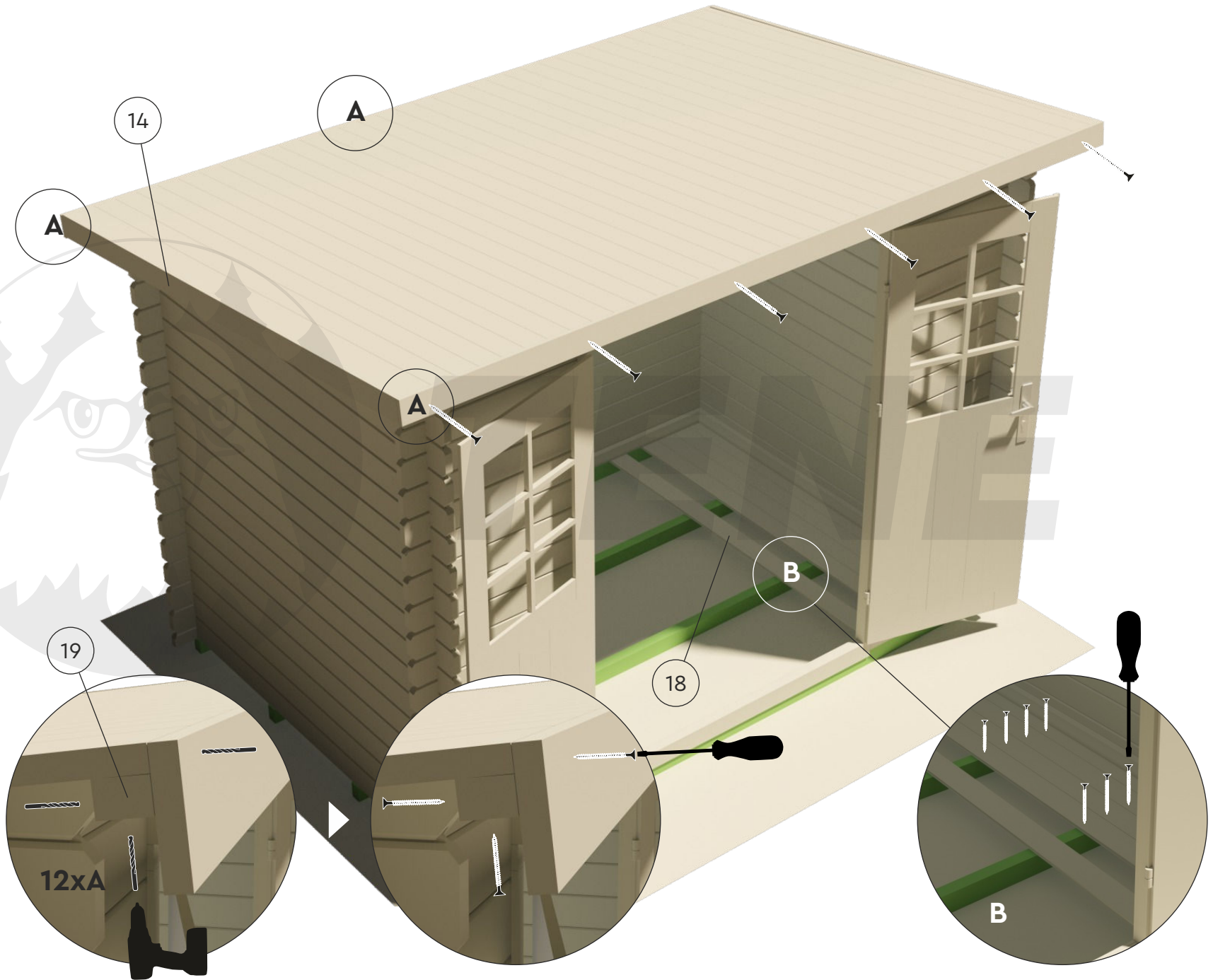

# MARY 1

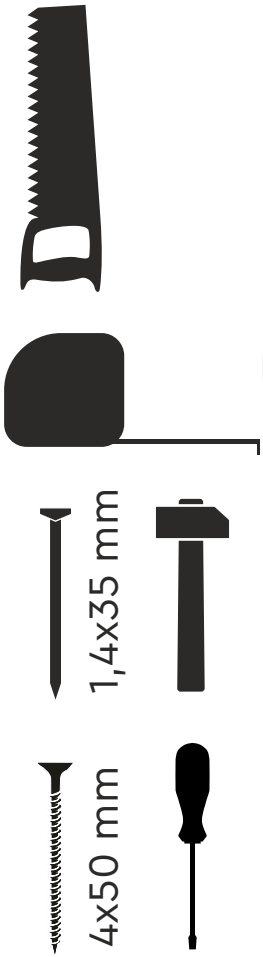

10/12

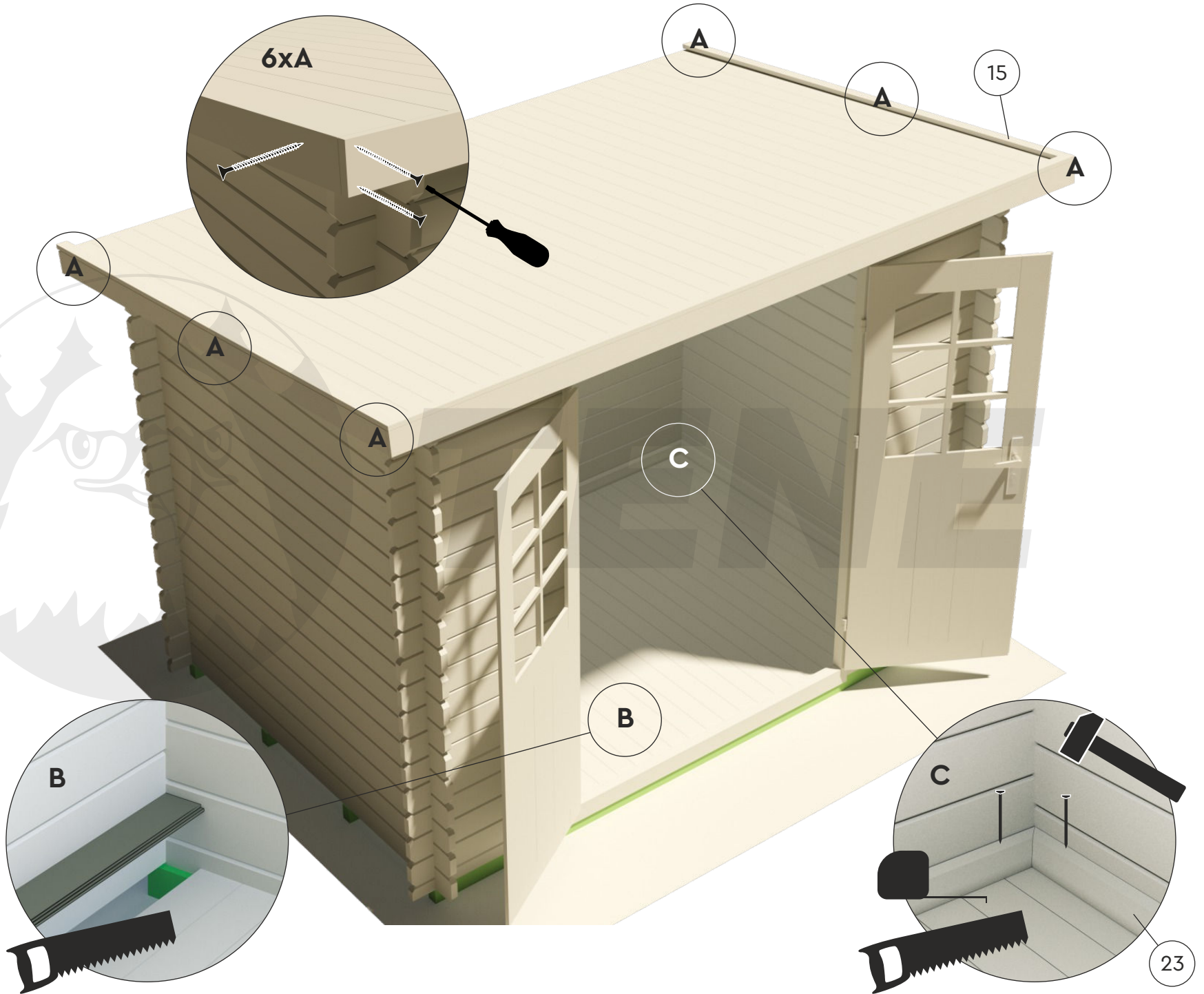

23

# MARY 1

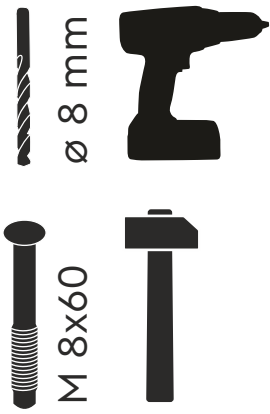
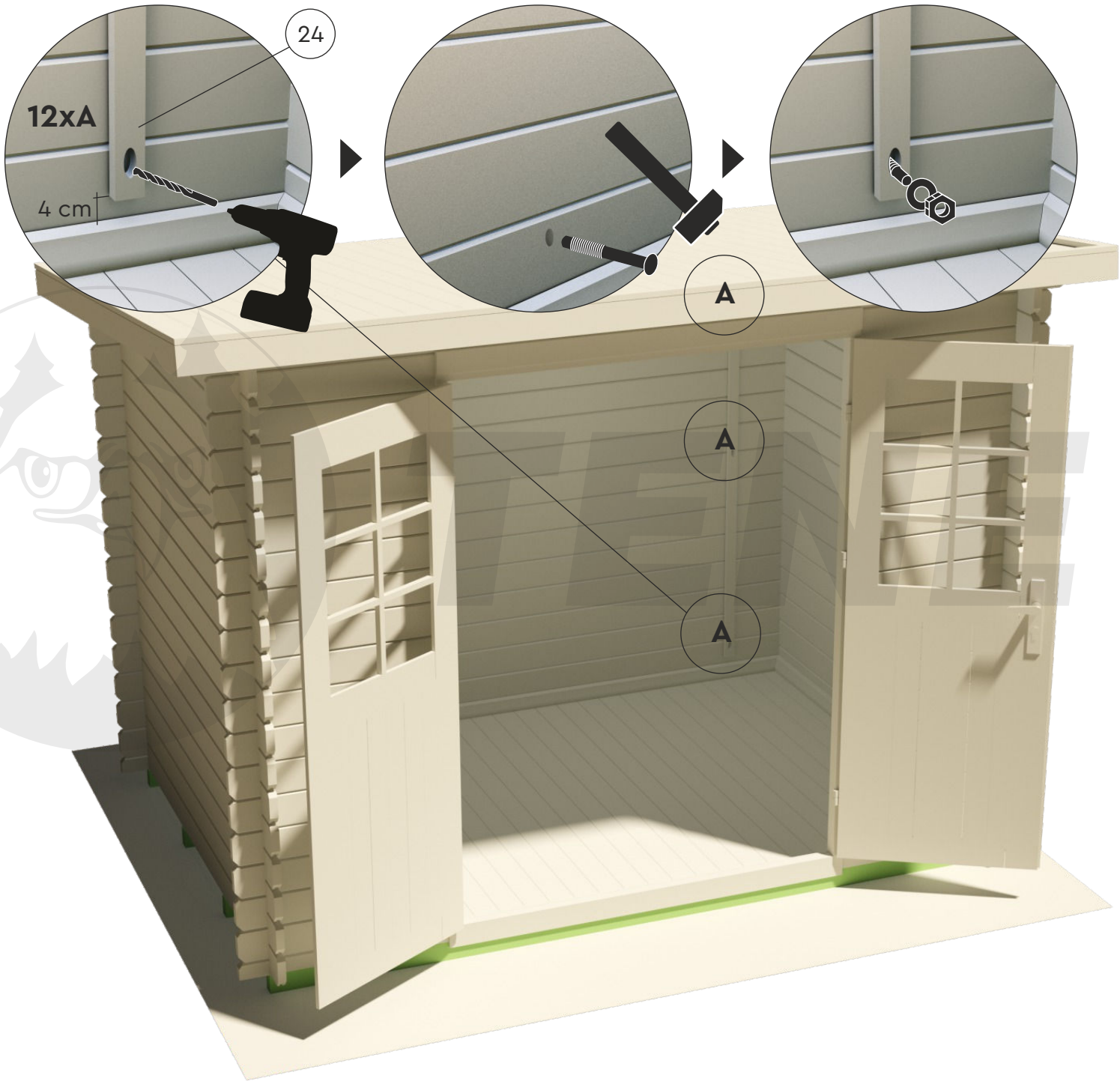

MARY 1

