

Adelle 2020/140

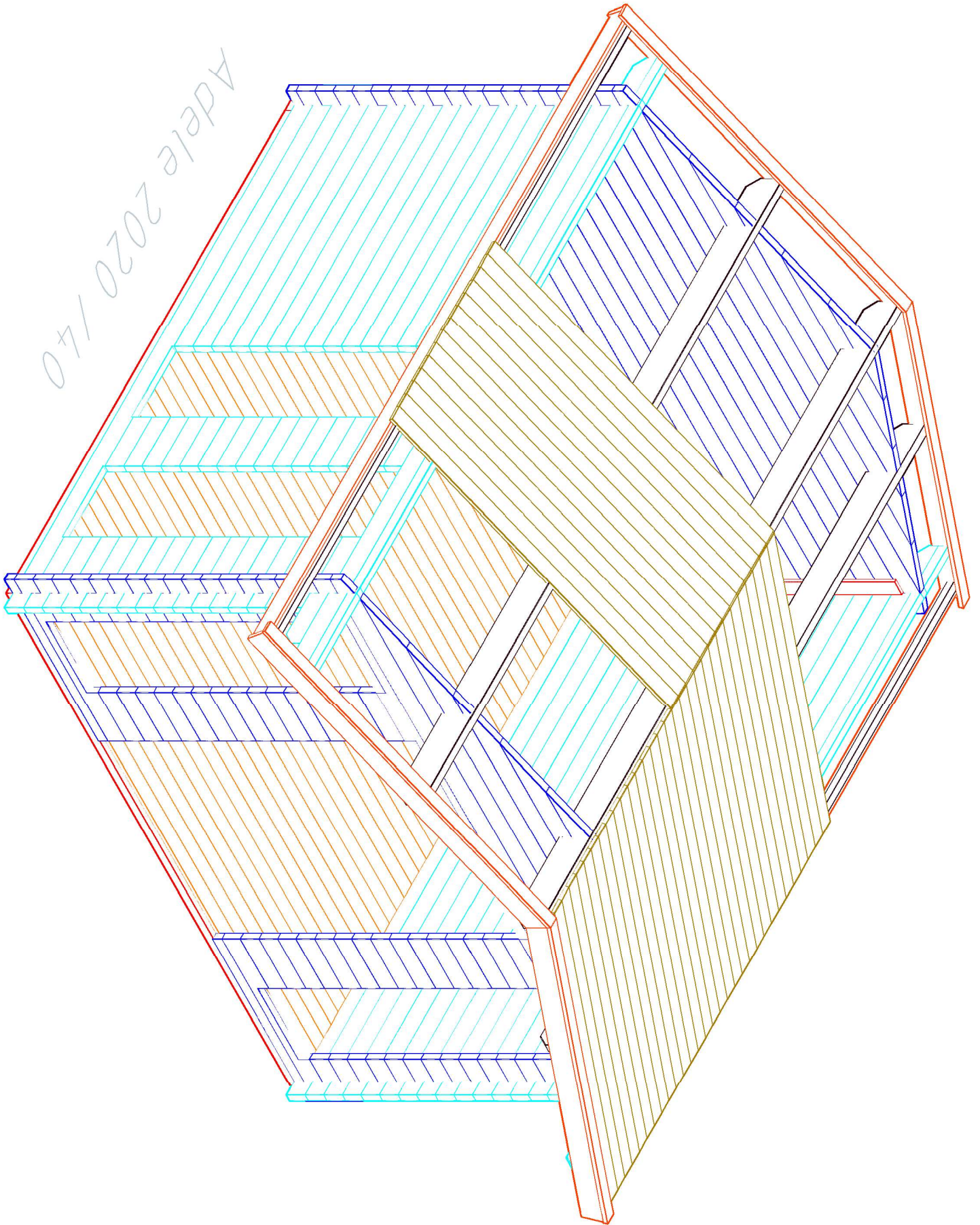

# Adele / 40

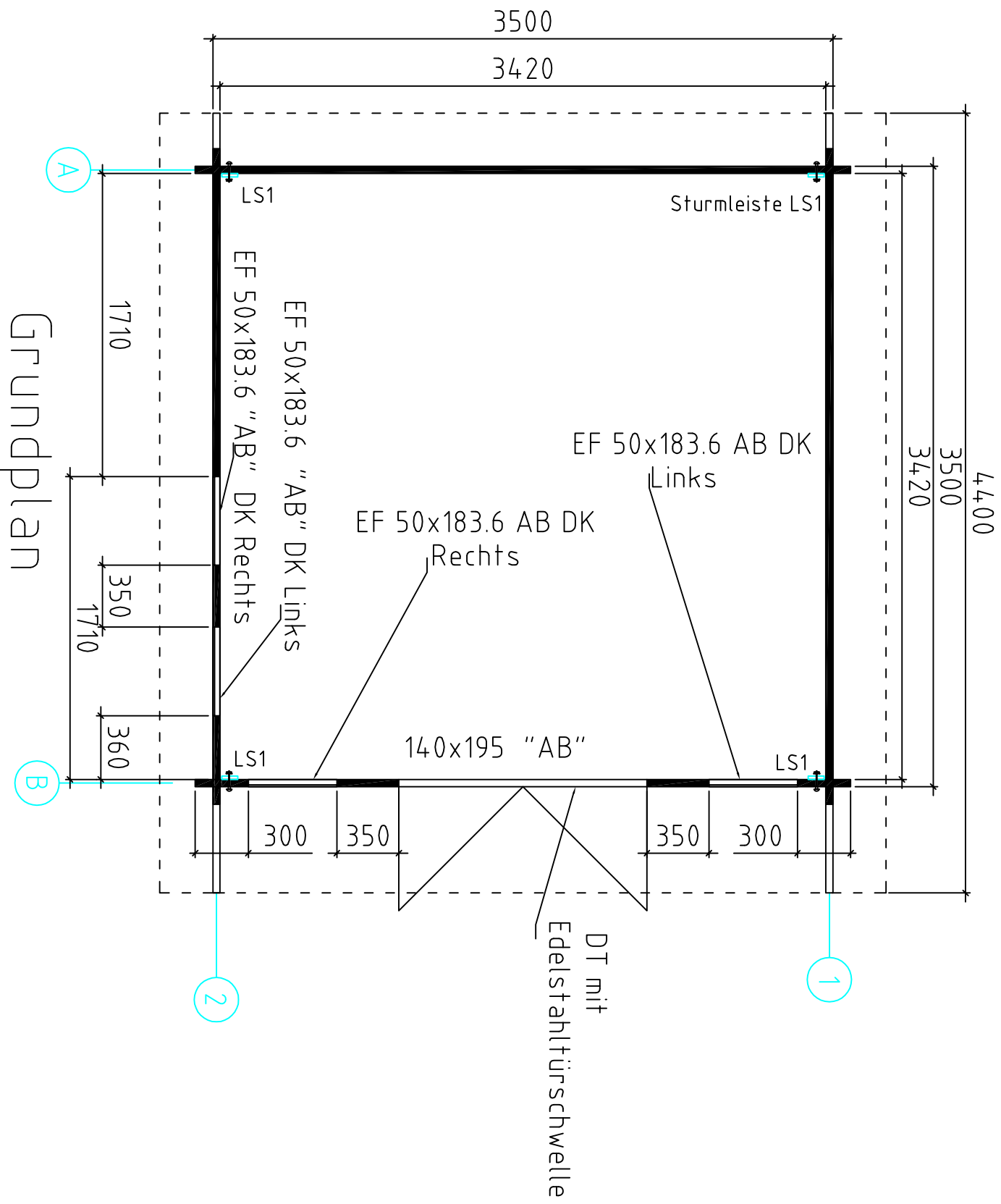

Grundplan

# Adelle / 40

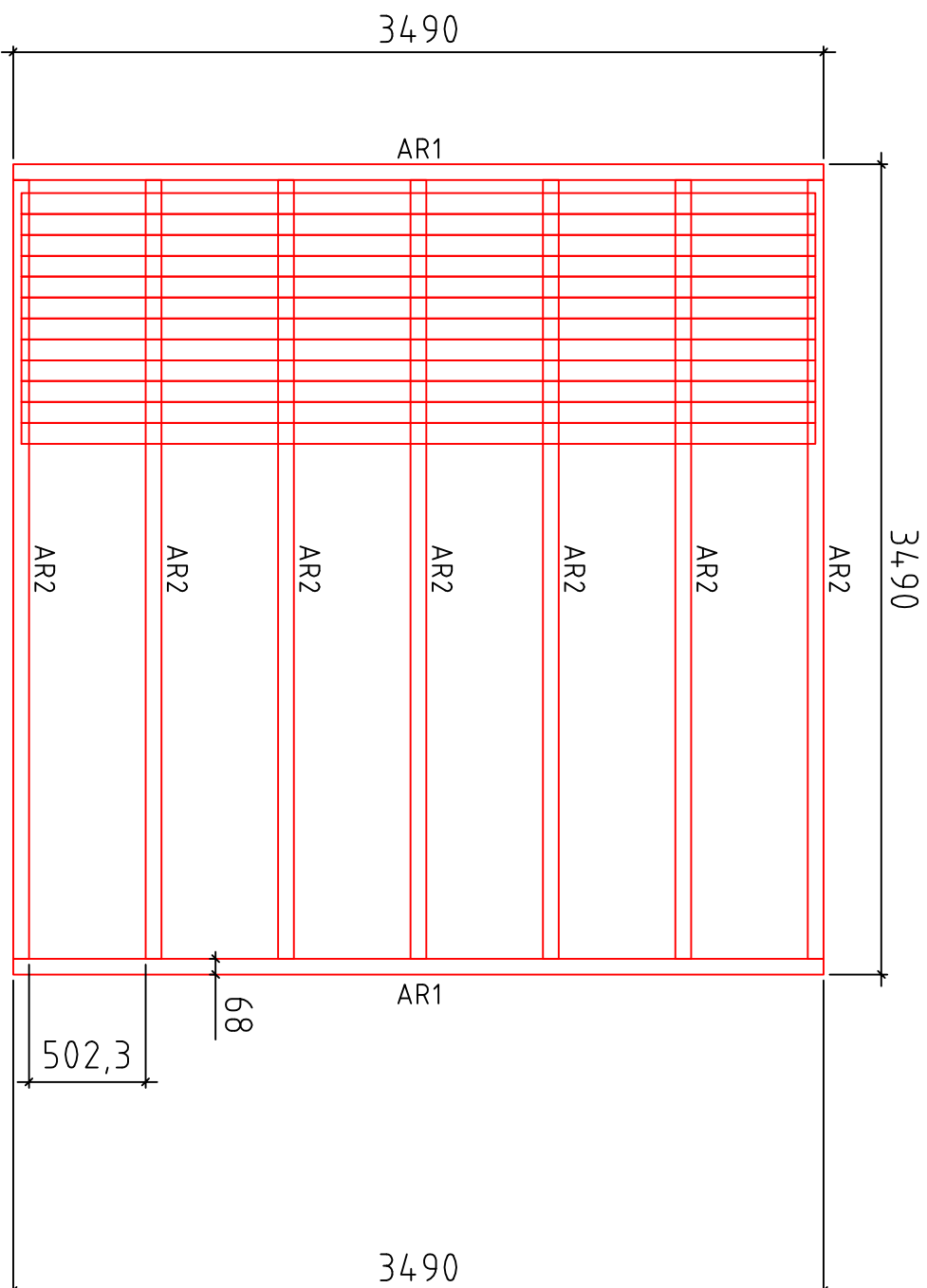

Fundament 68x44 (AR) und Fussboden 90x20

# Adelle / 40

4400

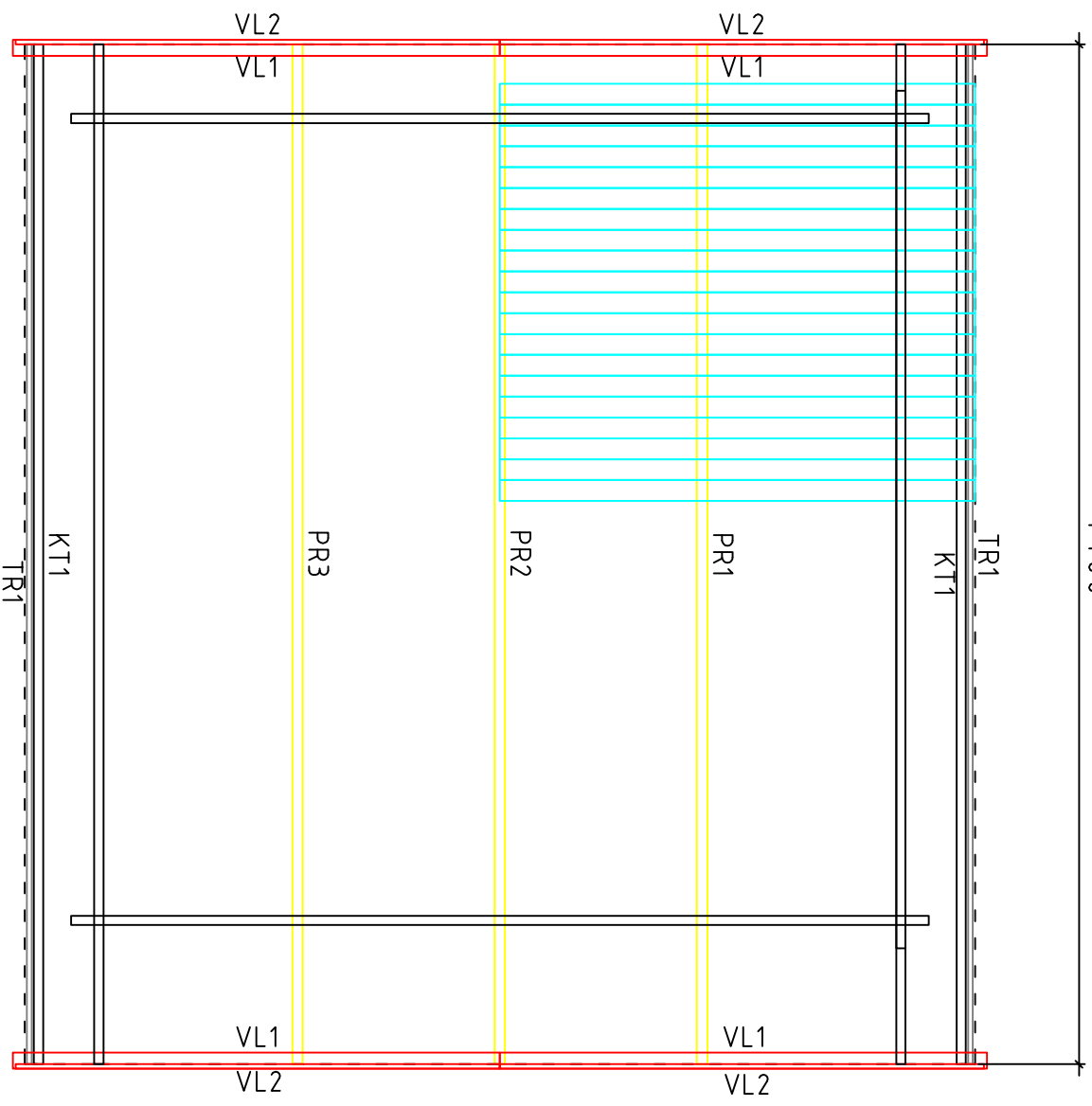

Dachbalken 45x190 (PR)

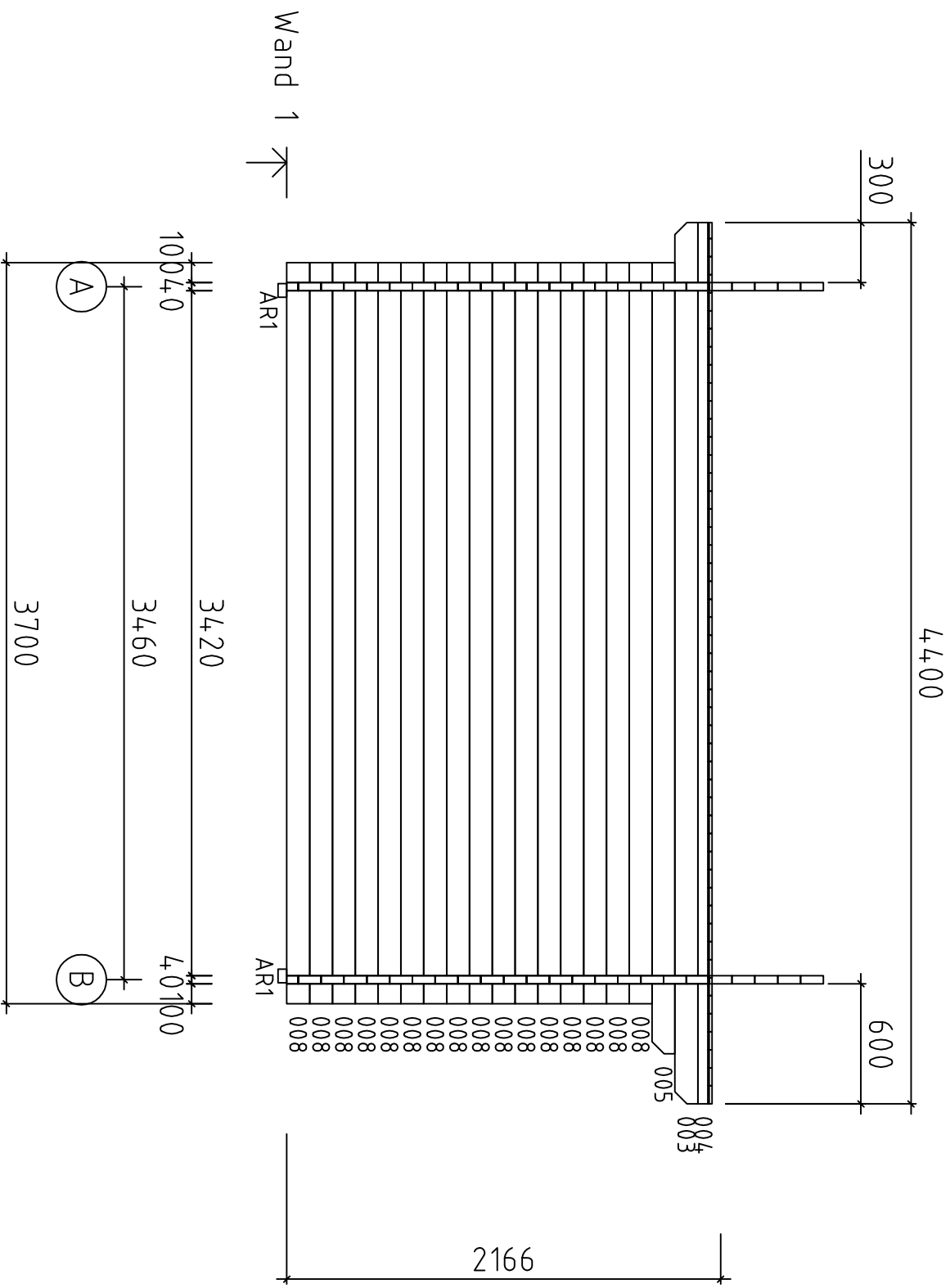

Adelle / 40

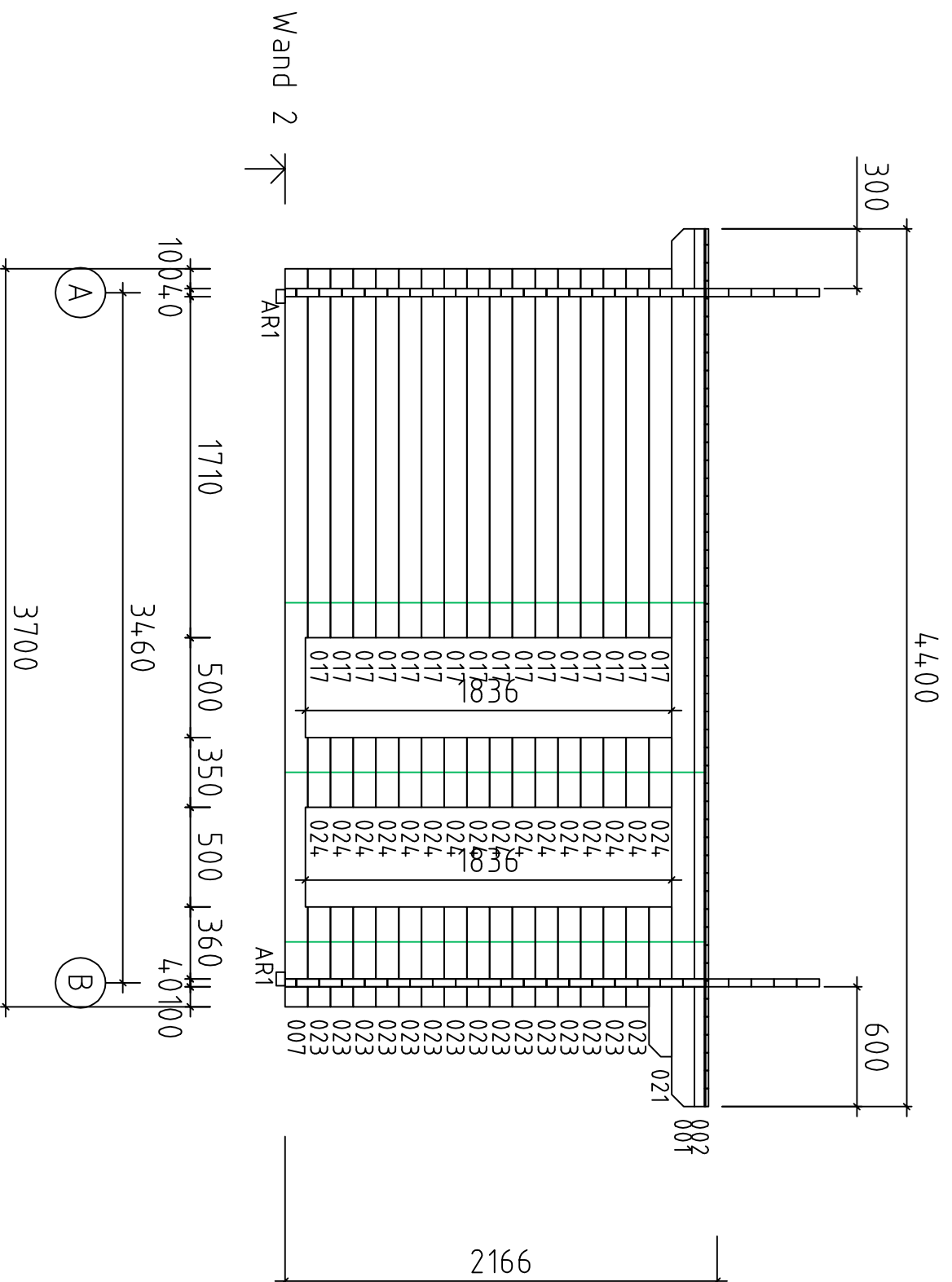

Adelle / 40

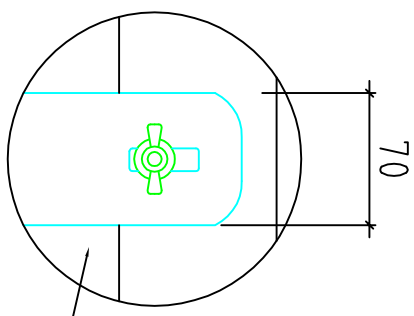

Wand A ↗

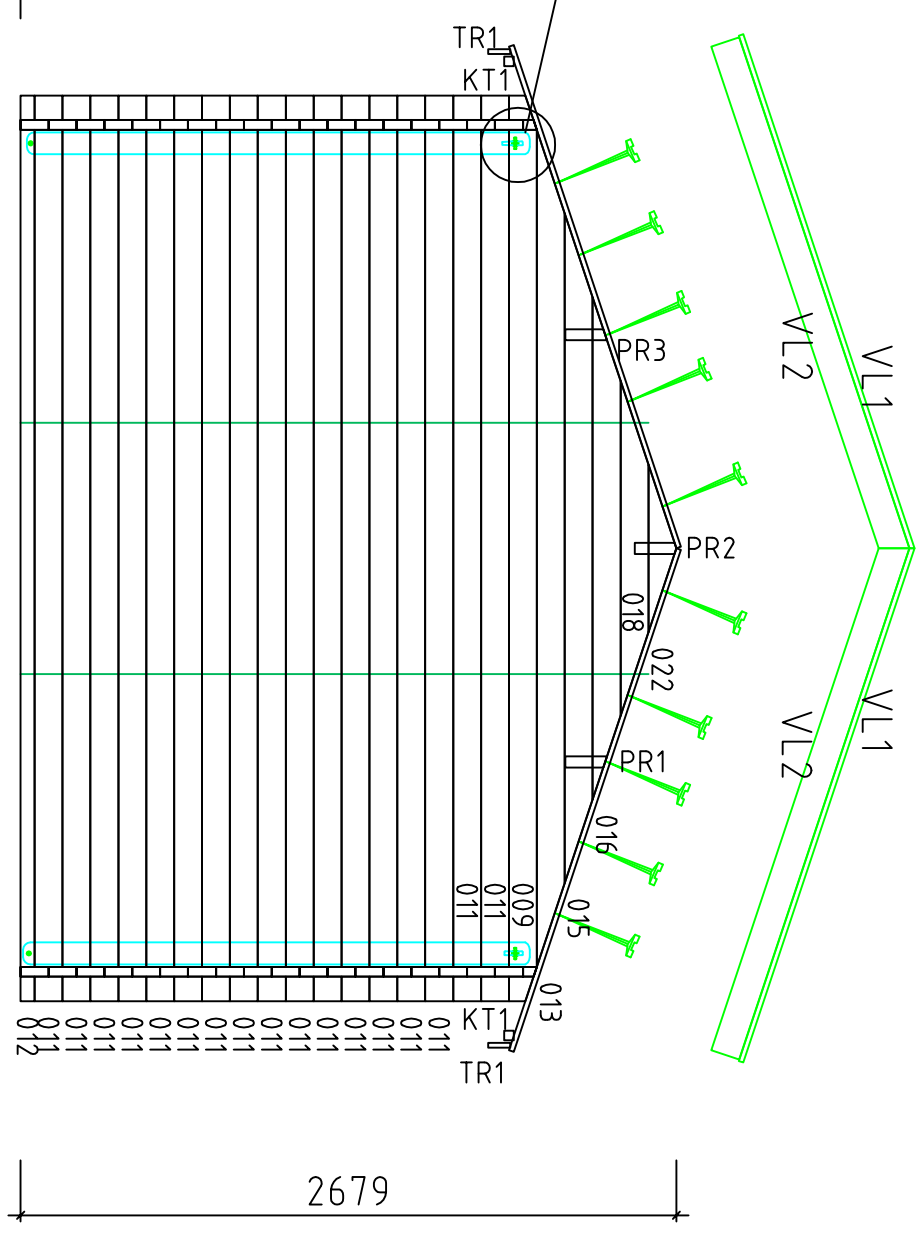

Adelle / 40





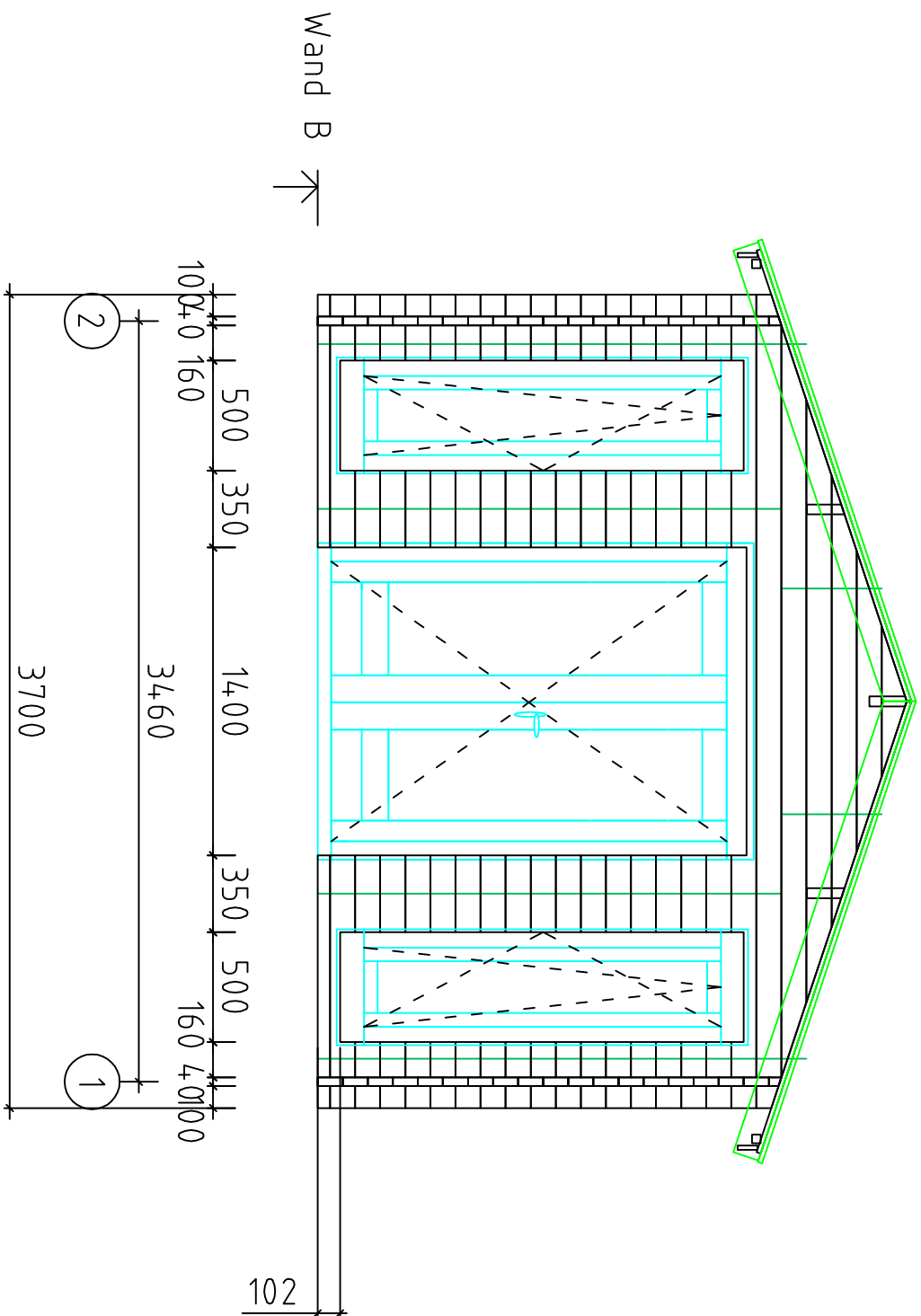



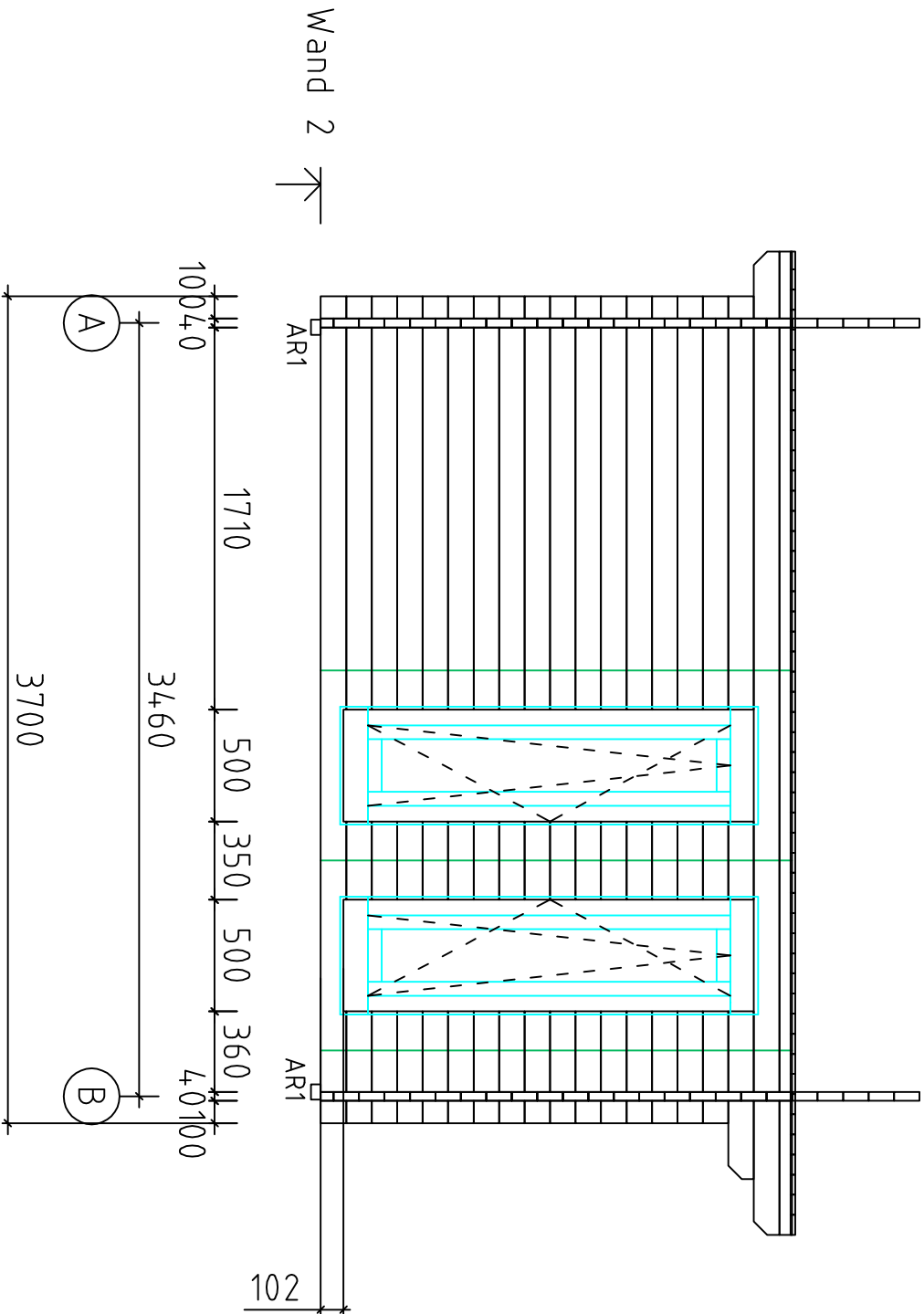



Adelle / 40





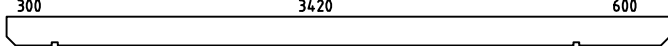
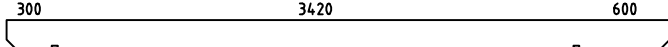
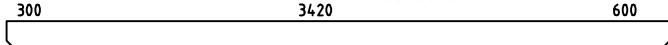

Adelle / 40

Pos	Adele i.p./40	ST	F (mm)	L (mm)
001		1	40x114	4400
002		1	40x57	4400
003		1	40x114	4400
004		1	40x57	4400
005		1	40x114	3950
006		1	40x114	3700
007		1	40x114	3700
008		16	40x114	3700
009		1	40x114	3700
010		1	40x114	3700
011		17	40x114	3700
012		1	40x57	3700
013		1	40x114	3420
014		1	40x114	3420
015		2	40x114	2736
016		2	40x114	2052
017		16	40x114	1850
018		2	40x114	1368
019		2	40x57	1150
020		2	40x114	1150
021		1	40x114	750
022		2	40x114	684
023		15	40x114	500
024		46	40x114	350
025		30	40x114	300

Pos	Adele i.p./40	ST	F (mm)	L (mm)
KT1	Karnisen träger 	2	40x40	4400
TR1	Traufenbrett 	2	20x90	4400
VL1	Giebelbretter 	4	70x20	2210
VL2	Giebelbretter 	4	20x120	2200
PR3	Dachbalken 	1	45x190	4400
PR1	Dachbalken 	1	45x190	4400
PR2	Dachbalken 	1	45x190	4400
0206-1	Dachbretter 	98	90x20	2160
	Abdeckleiste 		20x40	25m
	DÜBEL	63	11,2x11,2	390

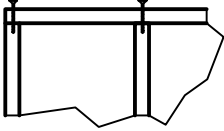
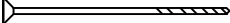
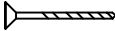
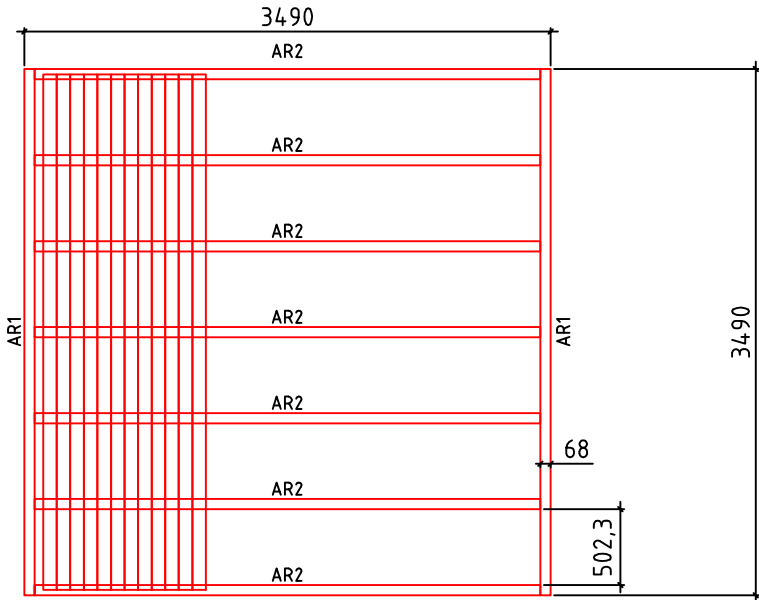

Pos	Adele i.p./40			ST	F (mm)	L (mm)	
Sturmleiste LS1		LS1		4	70x25	2050	
			Bolzen spez.		4	M8x80	
		Torx	Schrauben 3,5x50		4		
Dachbretter		Torx	Schrauben 3,5x50		600		
Montagematerial	Giebel Dachbalken Giebelbretter Traufenbretter u.s.w.	Torx	Schrauben 6x130		70		
		Torx	Schrauben 3,5x50		200		

Pos	Adele /40 F/F		ST	F (mm)	L (mm)
AR1	 Fundamentbalken	Impregniert	2	68x44	3490
AR2	 Fundamentbalken	Impregniert	7	68x44	3354
0203-1	Fussbodenbretter		37	90x20	3418
	Abdeckleiste			20x40	15m
Fundament		<span>Torx</span> Schrauben 6x130 	40		
Fussboden Abdeckleiste		<span>Torx</span> Schrauben 3,5x50 	280		
					
Kood	Materjal	File	trükk.dwg	Leht	2/3