

Shelter 1

1850 x 2540

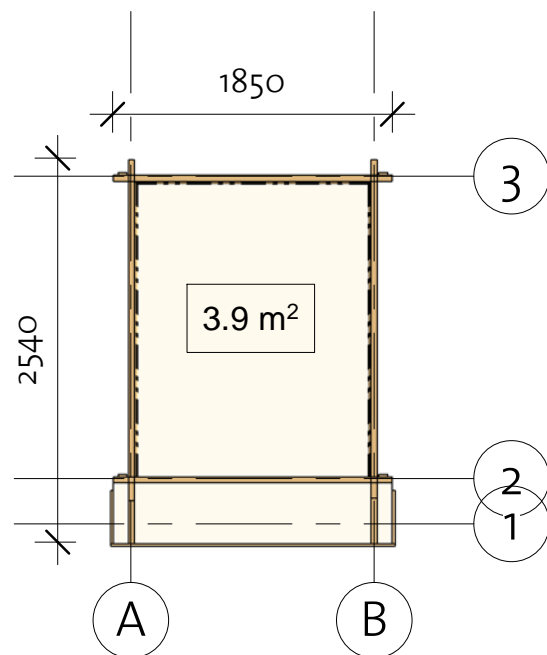

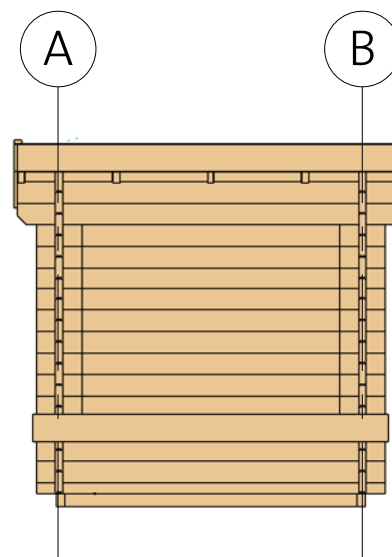
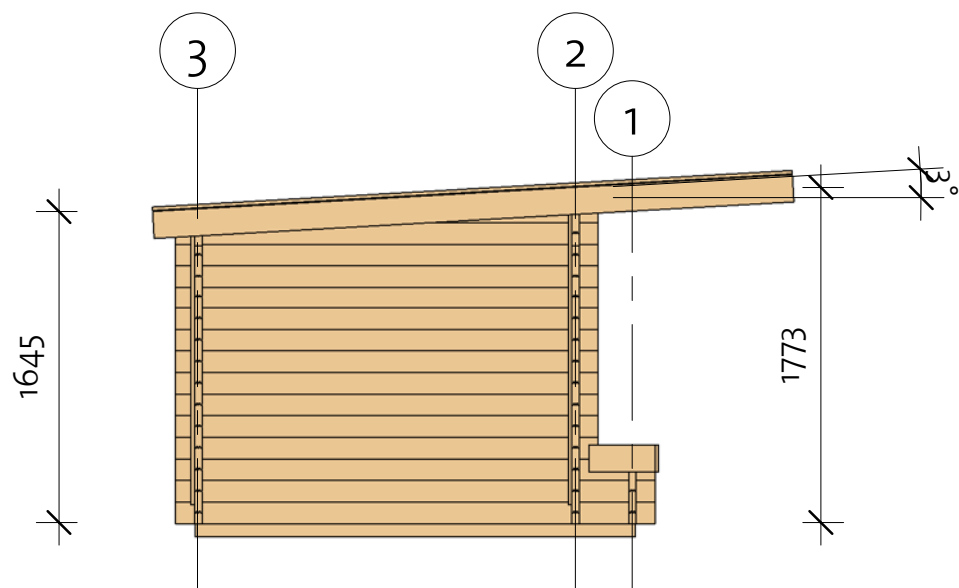

SØLUND

Shelter 1

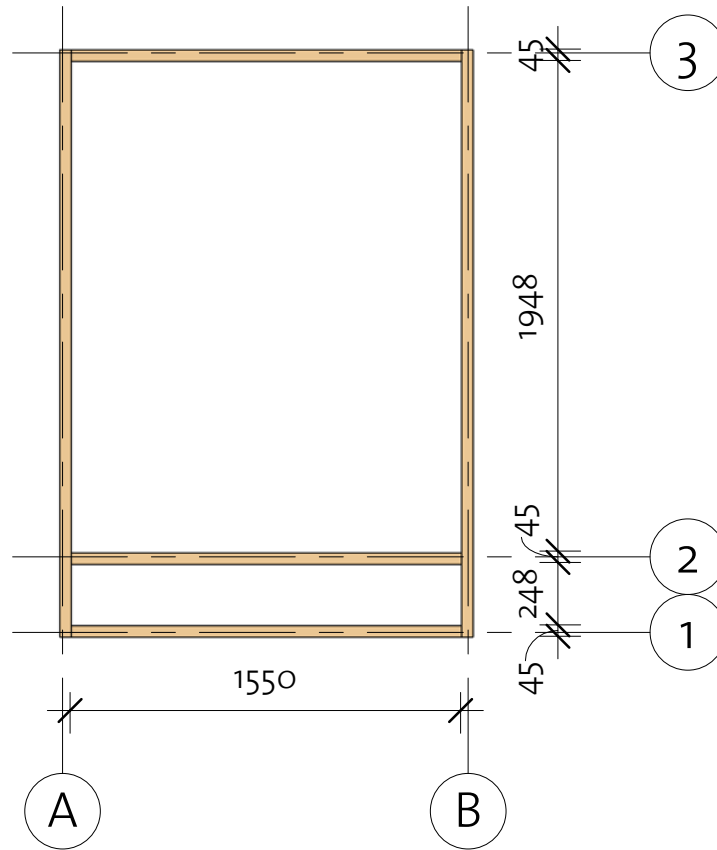
Foundation



| Impregnated foundation beams | | | | |
|------------------------------|--------------|---|-------|--------|
| Mark | Type | Profile | Count | Length |
| IFB1 | IFB 45x70 |  | 3 | 1550 |
| IFB2 | IFB 45x70 |  | 2 | 2330 |



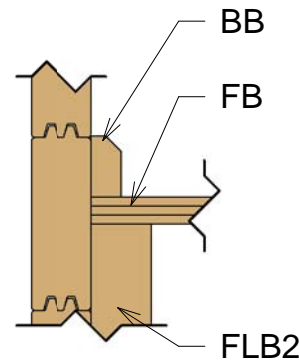
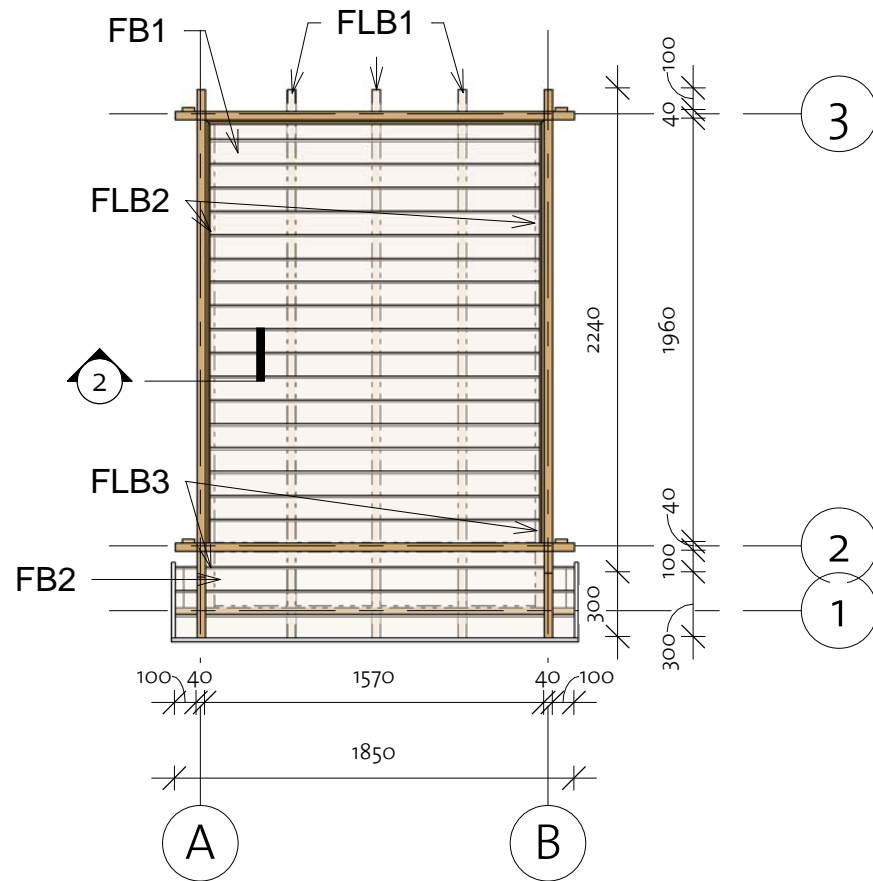

Shelter 1

Floor Plan



| | | | | |
|-----|-------------|---|---|------|
| BB1 | BB 20X40 |  | 2 | 3040 |
| BB2 | BB 20X40 | | 2 | 2040 |

| Floor Schedule | | | | |
|----------------|------|---------|-------|--------|
| Mark | Type | Profile | Count | Length |

| | | | | |
|------|----------------------|---|----|------|
| FB1 | FB 18x110 |  | 20 | 1570 |
| FB2 | FB 18x110 |  | 4 | 1850 |
| FLB1 | Floor beam 40X120 |  | 3 | 2540 |
| FLB2 | Floor beam 40X90 |  | 2 | 1960 |
| FLB3 | Floor beam 40X90 |  | 2 | 260 |

Shelter 1

Wall 1

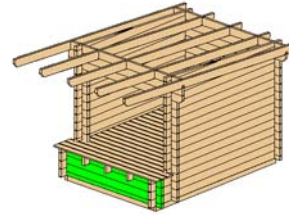

| Wall 1 | | | |
|--------|---------|-------|------------|
| Mark | Profile | Count | Cut Length |

| | | | |
|-------|--------|---|------|
| 1BL-1 | 40X57 | 1 | 1850 |
| 1LG-1 | 40X114 | 2 | 1850 |
| 1TL-1 | 40X114 | 1 | 1850 |

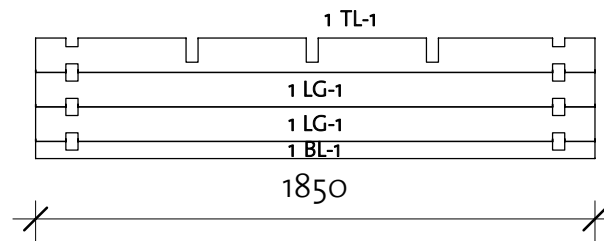

| Log Profile Wall 1 | |
|--------------------|---------|
| Profile | Profile |

| | |
|--------|--|
| 40X57 | |
| 40X114 | |
| 40X114 | |

Shelter 1

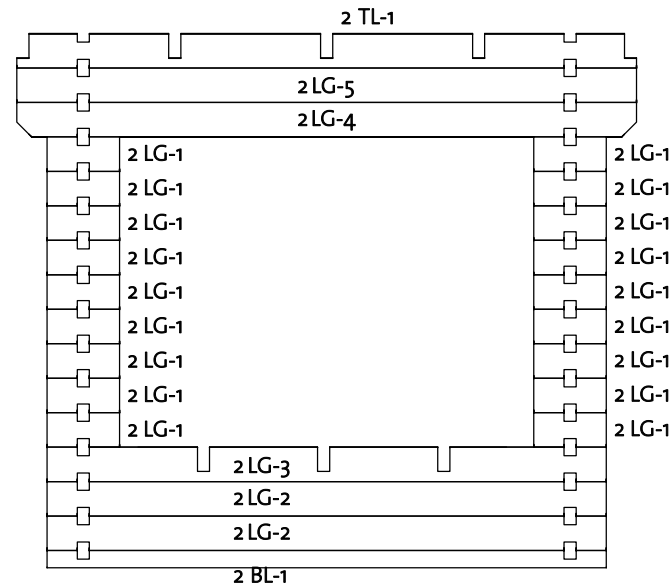
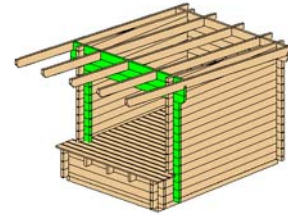

Wall 2



| Wall 2 | | | |
|--------|---------|-------|------------|
| Mark | Profile | Count | Cut Length |

| | | | |
|-------|--------|----|------|
| 2BL-1 | 40X57 | 1 | 1850 |
| 2LG-1 | 40X114 | 18 | 240 |
| 2LG-2 | 40X114 | 2 | 1850 |
| 2LG-3 | 40X114 | 1 | 1850 |
| 2LG-4 | 40X114 | 1 | 2050 |
| 2LG-5 | 40X114 | 1 | 2050 |
| 2TL-1 | 40X114 | 1 | 2050 |

| Log Profile Wall 2 | |
|--------------------|---------|
| Profile | Profile |

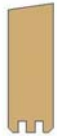
| | |
|--------|---|
| 40X57 |  |
| 40X114 |  |
| 40X114 |  |

Shelter 1

Wall 3

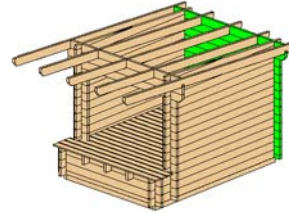

| Wall 3 | | | |
|--------|---------|-------|------------|
| Mark | Profile | Count | Cut Length |

| | | | |
|-------|--------|----|------|
| 3BL-1 | 40x57 | 1 | 1850 |
| 3LG-1 | 40x114 | 11 | 1850 |
| 3LG-2 | 40x114 | 1 | 1850 |
| 3LG-3 | 40x114 | 1 | 2050 |
| 3TL-1 | 40x114 | 1 | 2050 |

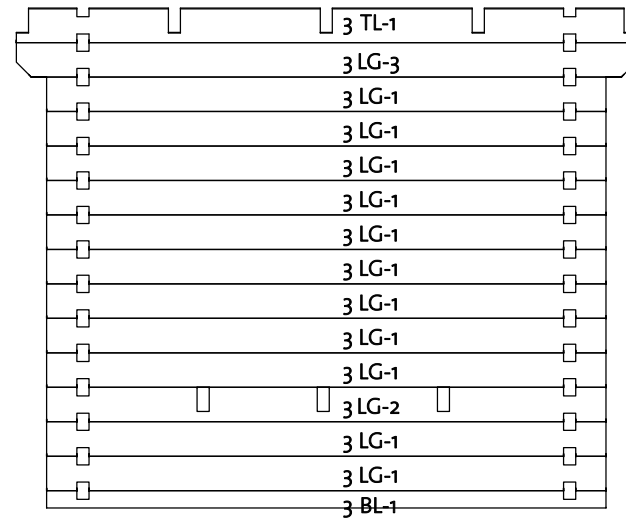

| Log Profile Wall 3 | |
|--------------------|---------|
| Profile | Profile |

| | |
|--------|--|
| 40x57 | |
| 40x114 | |
| 40x114 | |

Shelter 1

Wall A

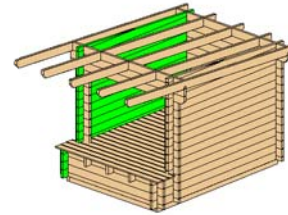

| Wall A | | | |
|--------|---------|-------|------------|
| Mark | Profile | Count | Cut Length |

| | | | |
|-------|--------|----|------|
| ALG-1 | 40x114 | 1 | 1100 |
| ALG-2 | 40x114 | 1 | 2240 |
| ALG-3 | 40x114 | 10 | 2240 |
| ALG-4 | 40x114 | 1 | 2540 |
| ALG-5 | 40x114 | 3 | 2540 |

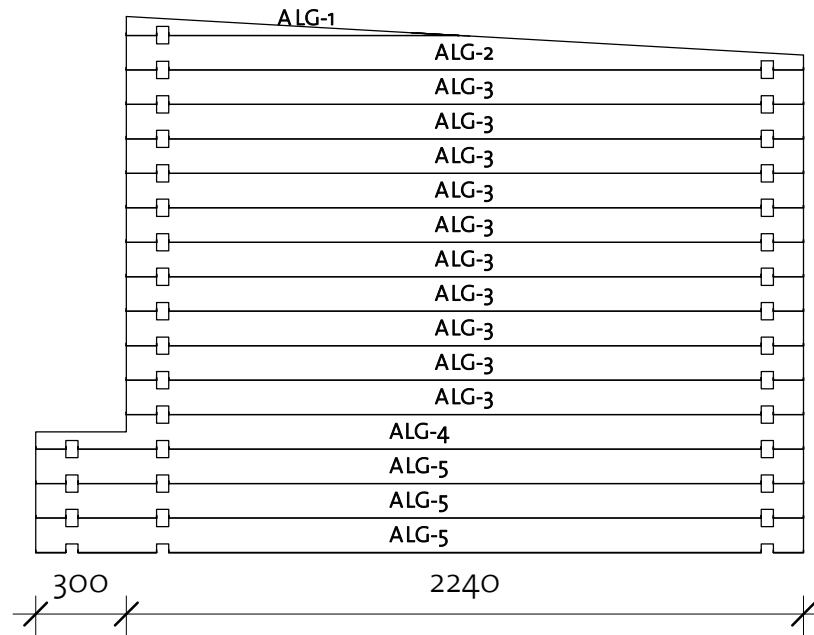

| Log Profile Wall A | |
|--------------------|---------|
| Profile | Profile |

| | |
|--------|--|
| 40x114 | |
|--------|--|

Shelter 1

Wall B

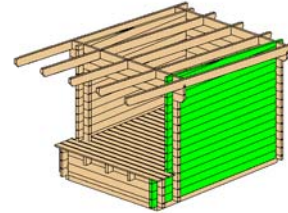

| Wall B | | | |
|--------|---------|-------|------------|
| Mark | Profile | Count | Cut Length |

| | | | |
|-------|--------|----|------|
| BLG-1 | 40X114 | 1 | 1000 |
| BLG-2 | 40X114 | 1 | 2240 |
| BLG-3 | 40X114 | 10 | 2240 |
| BLG-4 | 40X114 | 1 | 2540 |
| BLG-5 | 40X114 | 3 | 2540 |

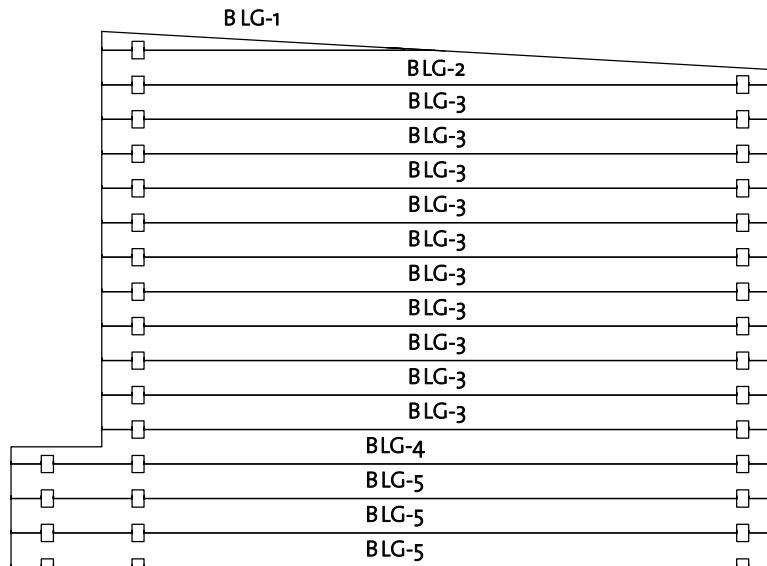

| Log Profile Wall B | |
|--------------------|---------|
| Profile | Profile |

| | |
|--------|--|
| 40X114 | |
|--------|--|



Shelter 1

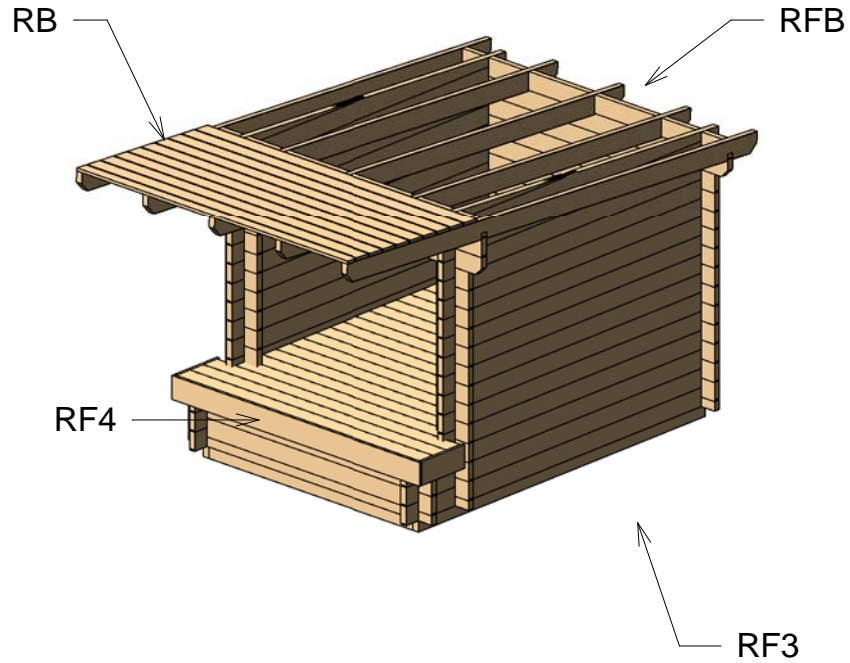

Roof 1

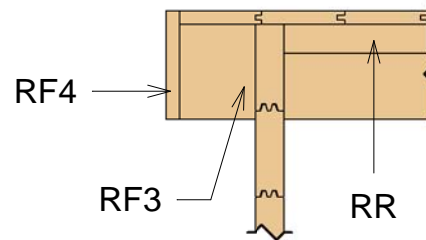

① Floor Facia



| Roof | | | | |
|------|----------------|---|-------|--------|
| Mark | Type | Profile | Count | Length |
| RFB | Beam 40x120 |  | 5 | 3350 |
| RB | 18x110 |  | 32 | 2050 |

| Floor Facia | | | | |
|-------------|--------------------------------|---|-------|--------|
| Mark | Type | Profile | Count | Length |
| RF3 | Roof Fascia 18x143 |  | 2 | 350 |
| RF4 | Roof Fascia 18x143 |  | 1 | 1886 |
| RR | Roof reinforcement 38x38 |  | 2 | 190 |

Shelter 1

Roof 2

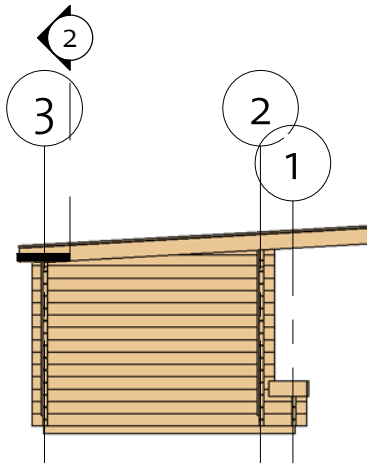

② Facia

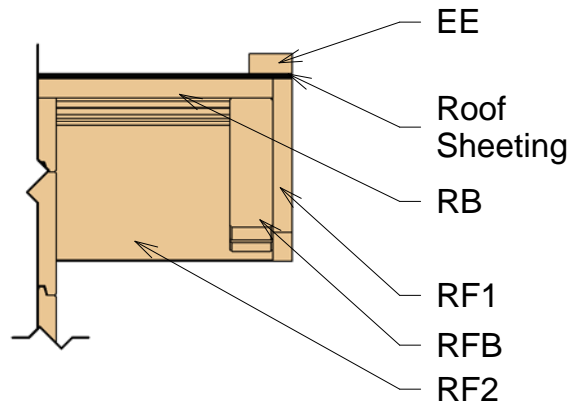

③

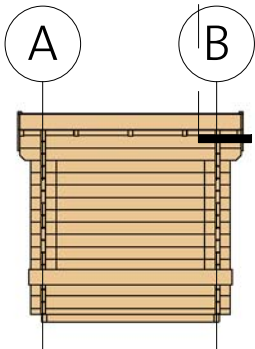

③ Roof Reinforcement

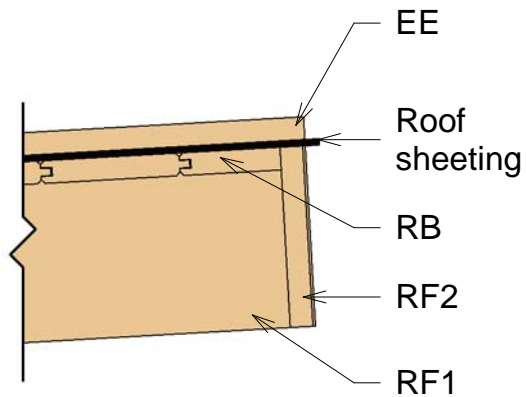

Fascia Schedule

| Mark | Type | Profile | Count | Length |
|------|-----------------------|---------|-------|--------|
| EE | Eave Edging 18x40 | | 2 | 3390 |
| RF1 | Roof Fascia 18x143 | | 2 | 3390 |
| RF2 | Roof Fascia 18x143 | | 2 | 2050 |

Shelter 1

Extras

| Fasteners/Extras | | |
|------------------|------|-------|
| Name | Type | Count |

| | | |
|----------|------------|-----|
| Hitblock | 300-400 mm | |
| Nails | 1,4 x 40 | 30 |
| Screws | 5,0x 70 | 60 |
| Screws | 6,0 x 140 | 60 |
| Screws | 4,0 x 40 | 70 |
| Screws | 4,0 x 50 | 290 |







| Family | Count | Length |
|--------|-------|--------|
|--------|-------|--------|





| | | |
|--------------------|---|------|
| Windboard 18x38 | 2 | 1520 |
| Windboard 18x38 | 2 | 1650 |

Shelter 1

List of all items 1



| Roof | | | | |
|------|----------------|---|-------|--------|
| Mark | Type | Profile | Count | Length |
| RFB | Beam 40x120 |  | 5 | 3350 |
| RB | 18x110 |  | 32 | 2050 |



| Fascia Schedule | | | | |
|-----------------|-----------------------|--|-------|--------|
| Mark | Type | Profile | Count | Length |
| EE | Eave Edging 18x40 |  | 2 | 3390 |
| RF1 | Roof Fascia 18x143 |  | 2 | 3390 |
| RF2 | Roof Fascia 18x143 |  | 2 | 2050 |

| Floor Schedule | | | | |
|----------------|-------------------------|---|-------|--------|
| Mark | Type | Profile | Count | Length |
| FB1 | FB 18x110 |  | 20 | 1570 |
| FB2 | FB 18x110 |  | 4 | 1850 |
| FLB1 | Floor beam 40x120 |  | 3 | 2540 |
| FLB2 | Floor beam 40x90 |  | 2 | 1960 |
| FLB3 | Floor beam 40x90 |  | 2 | 260 |

Shelter 1

List of all items 2

| Floor Fascia | | | | |
|--------------|--------------------------------|---|-------|--------|
| Mark | Type | Profile | Count | Length |
| RF3 | Roof Fascia 18x143 |  | 2 | 350 |
| RF4 | Roof Fascia 18x143 |  | 1 | 1886 |
| RR | Roof reinforcement 38x38 |  | 2 | 190 |

| Impregnated foundation beams | | | | |
|------------------------------|--------------|---|-------|--------|
| Mark | Type | Profile | Count | Length |
| IFB1 | IFB 45x70 |  | 3 | 1550 |
| IFB2 | IFB 45x70 |  | 2 | 2330 |

Shelter 1

List of all items 3

| Wall 1 | | | |
|--------|---------|-------|------------|
| Mark | Profile | Count | Cut Length |

| | | | |
|-------|--------|---|------|
| 1BL-1 | 40X57 | 1 | 1850 |
| 1LG-1 | 40X114 | 2 | 1850 |
| 1TL-1 | 40X114 | 1 | 1850 |

| Wall 2 | | | |
|--------|---------|-------|------------|
| Mark | Profile | Count | Cut Length |

| | | | |
|-------|--------|----|------|
| 2BL-1 | 40X57 | 1 | 1850 |
| 2LG-1 | 40X114 | 18 | 240 |
| 2LG-2 | 40X114 | 2 | 1850 |
| 2LG-3 | 40X114 | 1 | 1850 |
| 2LG-4 | 40X114 | 1 | 2050 |
| 2LG-5 | 40X114 | 1 | 2050 |
| 2TL-1 | 40X114 | 1 | 2050 |

| Wall A | | | |
|--------|---------|-------|------------|
| Mark | Profile | Count | Cut Length |

| | | | |
|-------|--------|----|------|
| ALG-1 | 40X114 | 1 | 1100 |
| ALG-2 | 40X114 | 1 | 2240 |
| ALG-3 | 40X114 | 10 | 2240 |
| ALG-4 | 40X114 | 1 | 2540 |
| ALG-5 | 40X114 | 3 | 2540 |



| Wall B | | | |
|--------|---------|-------|------------|
| Mark | Profile | Count | Cut Length |

| | | | |
|-------|--------|----|------|
| BLG-1 | 40X114 | 1 | 1000 |
| BLG-2 | 40X114 | 1 | 2240 |
| BLG-3 | 40X114 | 10 | 2240 |
| BLG-4 | 40X114 | 1 | 2540 |
| BLG-5 | 40X114 | 3 | 2540 |



| Wall 3 | | | |
|--------|---------|-------|------------|
| Mark | Profile | Count | Cut Length |

| | | | |
|-------|--------|----|------|
| 3BL-1 | 40X57 | 1 | 1850 |
| 3LG-1 | 40X114 | 11 | 1850 |
| 3LG-2 | 40X114 | 1 | 1850 |
| 3LG-3 | 40X114 | 1 | 2050 |
| 3TL-1 | 40X114 | 1 | 2050 |

| Log Profiles | |
|--------------|---------|
| Profile | Profile |

| | |
|--------|---|
| 40X57 |  |
| 40X114 |  |

| Log Profiles | |
|--------------|---------|
| Profile | Profile |

| | |
|--------|---|
| 40X114 |  |
| 40X114 |  |