

Elisabeth 28 (380x280)

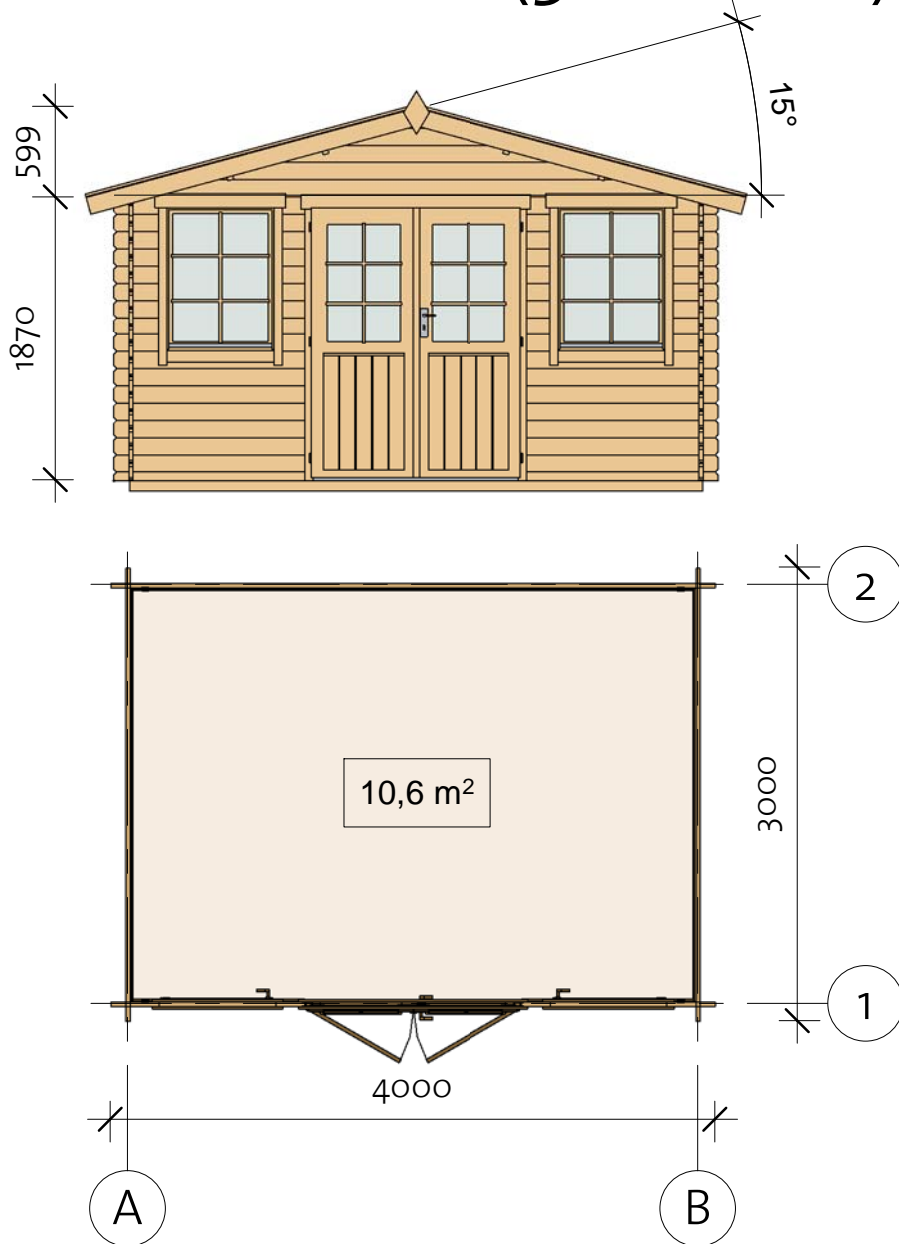

4000011_190220

Elisabeth 28 (380x280)

Foundation

Impregnated foundation beams				
Mark	Type	Profile	Count	Length

IFB	IFB 40x70		6	3790
-----	--------------	---	---	------



Elisabeth 28 (380x280)

Floor Plan

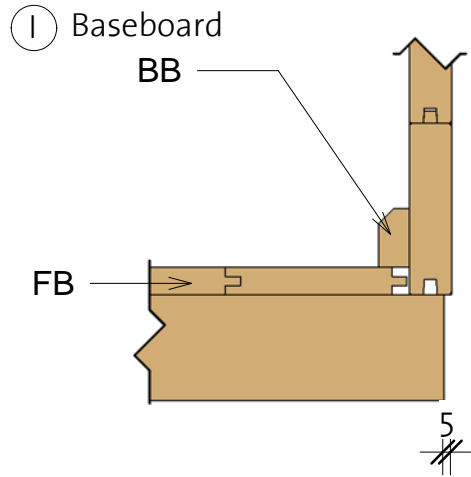

Floor Schedule				
Mark	Type	Profile	Count	Length
FB	FB 18x110		35	2740
BB1	BB 20x40		2	3800
BB2	BB 20x40		2	2800

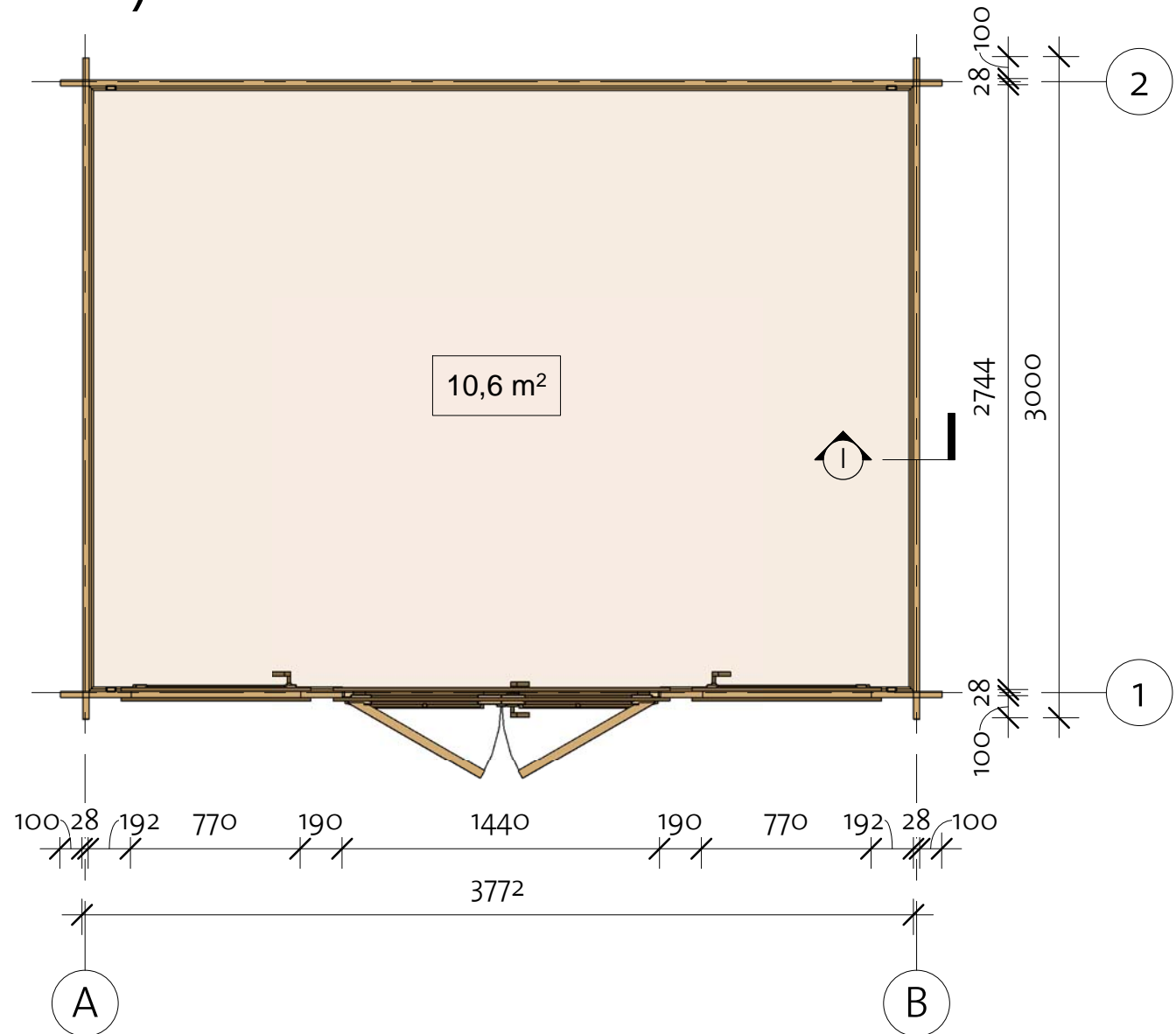

Elisabeth 28 (380x280)

Wall 1



Wall 1			
Mark	Profile	Count	Cut Length

1BL 1	28x57	2	1280
1LG 1	28x114	18	190
1LG 2	28x114	18	320
1LG 3 *	28x114	1	841
1LG 4 *	28x114	1	1683
1LG 5	28x114	14	1280
1LG 6 *	28x114	1	2477
1LG 7 *	28x114	1	3367
1LG 8 *	28x114	1	4000

*Gable-delivered premounted

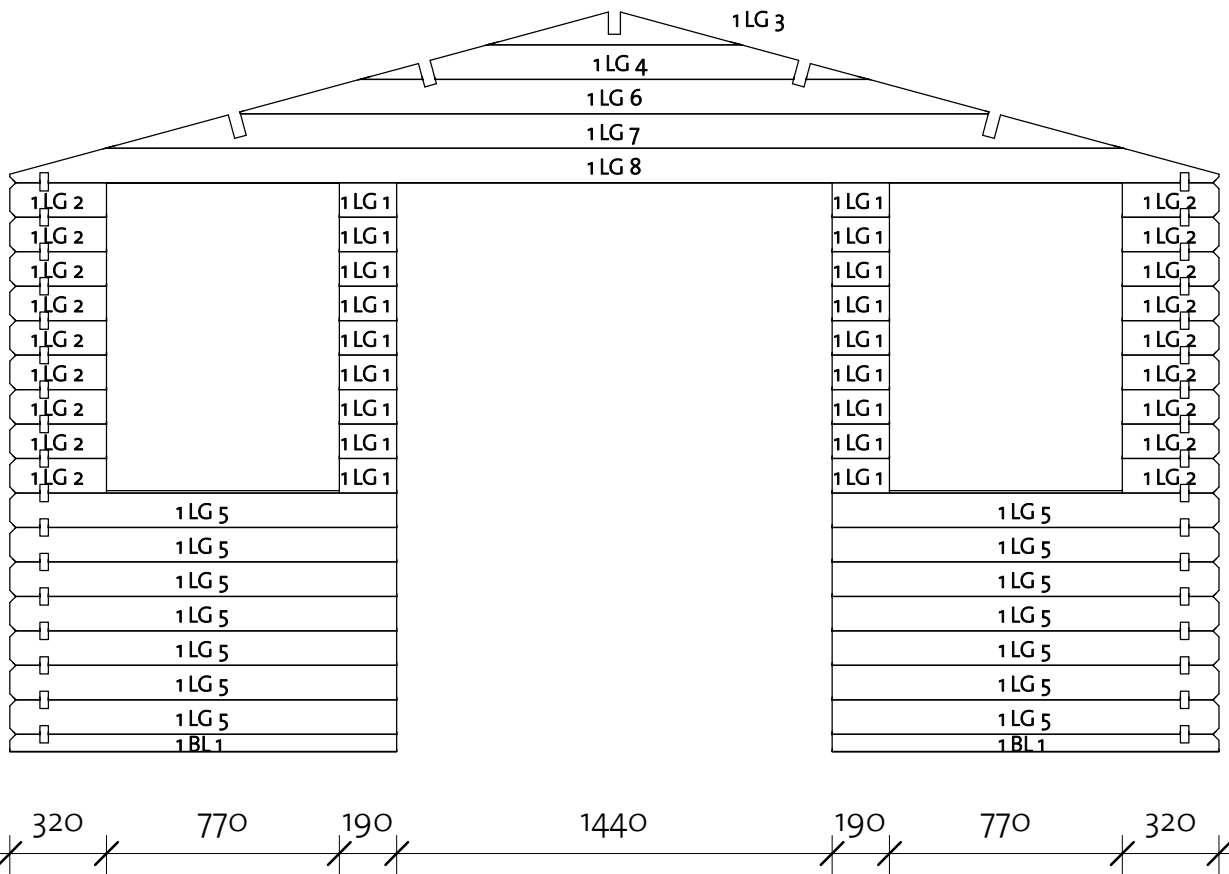

Log Profile Wall 1	
Profile	Profile

28x57	
28x114	

Elisabeth 28 (380x280)

Wall 2

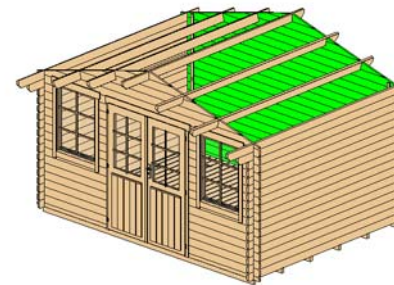

Wall 2			
Mark	Profile	Count	Cut Length

2BL 1	28x114	1	4000
2LG 1 *	28x114	1	841
2LG 2 *	28x114	1	1683
2LG 3 *	28x114	1	2477
2LG 4 *	28x114	1	3367
2LG 5 *	28x114	1	4000
2LG 6	28x114	16	4000

*Gable-delivered premounted

Log Profile Wall 2	
Profile	Profile

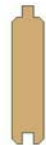
28x57	
28x114	

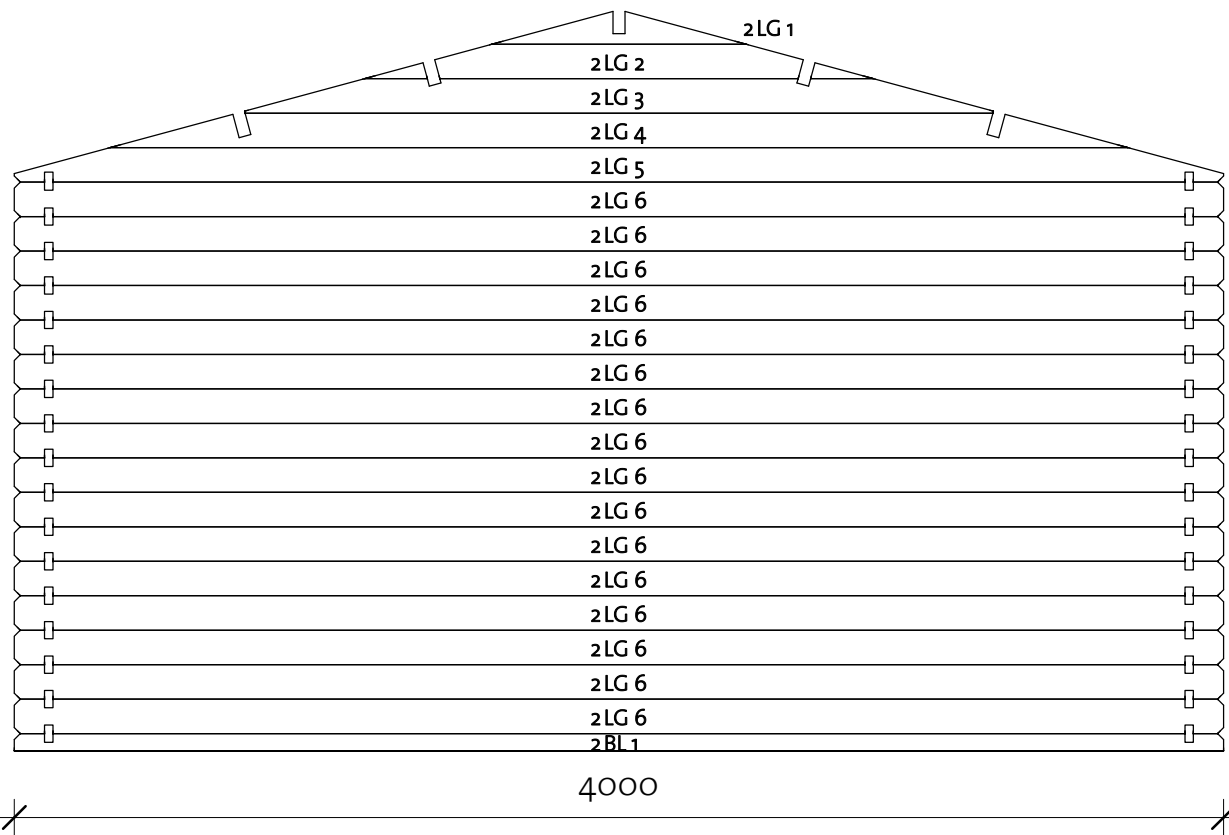

4000011_190220

Elisabeth 28 (380x280)

Wall A

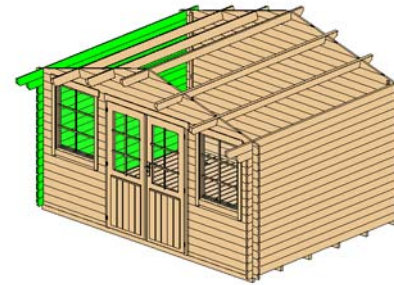

Wall A			
Mark	Profile	Count	Cut Length

ALG 1	28x114	15	3000
ALG 2	28x114	1	3200
ATL 1	28x120	1	3500

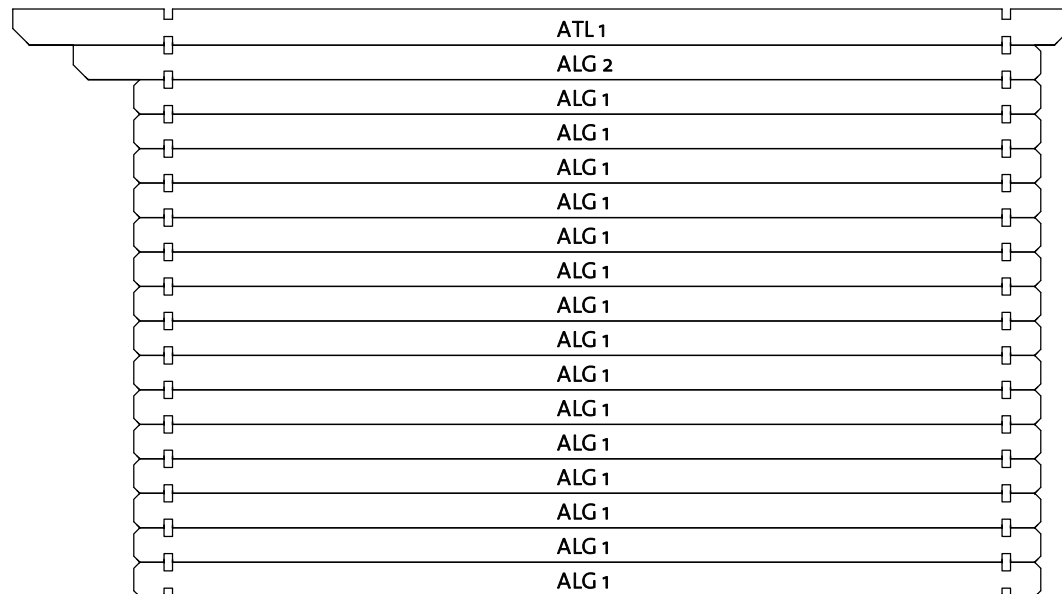

Log Profile Wall A	
Profile	Profile

28x114	
28x120	

4000011_190328

Elisabeth 28 (380x280)

Wall B

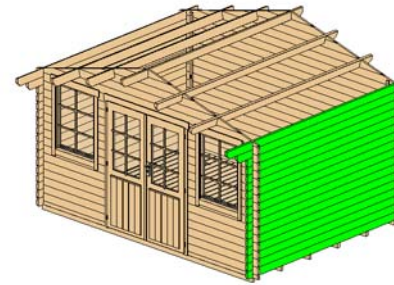

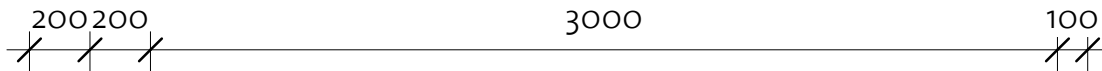
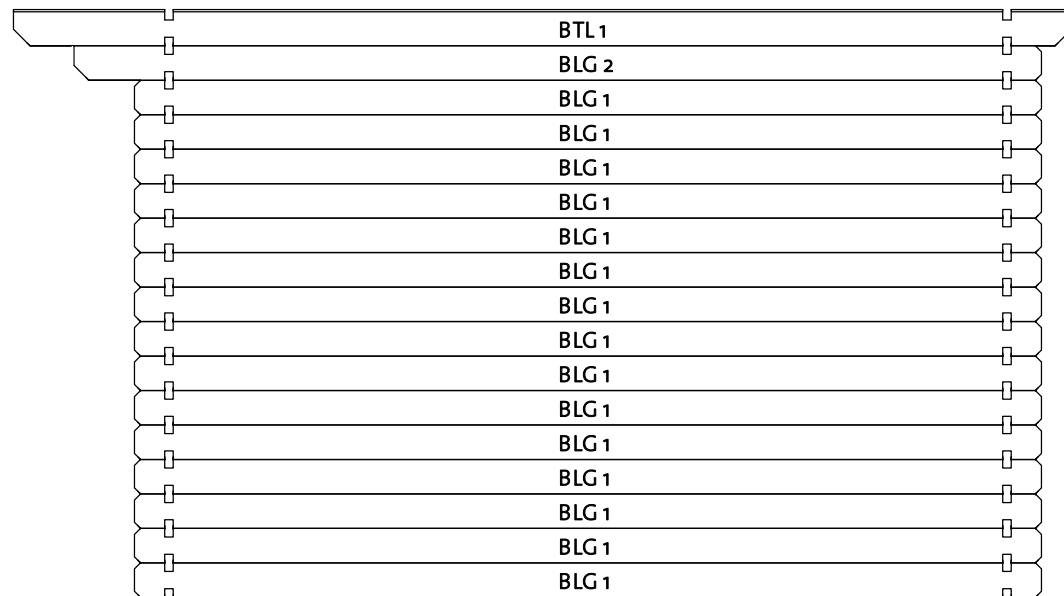

Wall B			
Mark	Profile	Count	Cut Length

BLG 1	28x114	15	3000
BLG 2	28x114	1	3200
BTL 1	28x120	1	3500







Log Profile Wall B	
Profile	Profile

28x114	
28x120	

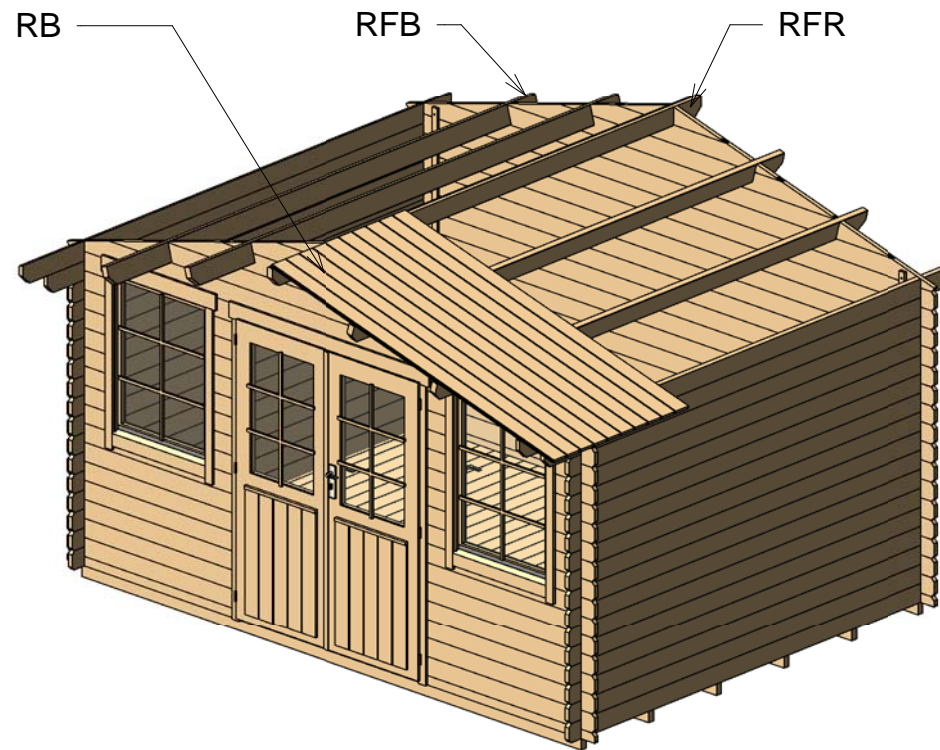
Elisabeth 28 (380x280)

Roof 1



Roof				
Mark	Type	Profile	Count	Length
RFR	Ridge 40x120		1	3500
RFB	Beam 40x120		4	3500
RB	18x110		66	2220

Elisabeth 28 (380x280)

Roof 2

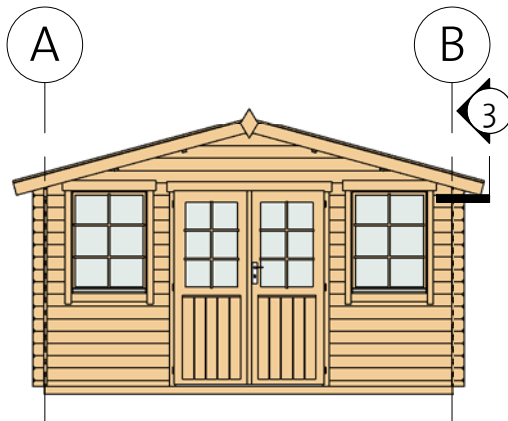
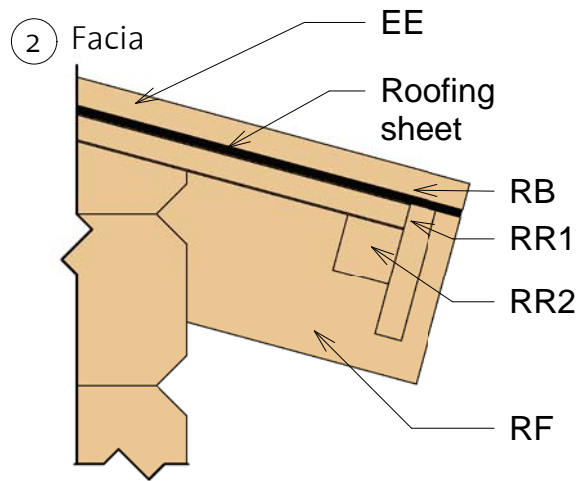
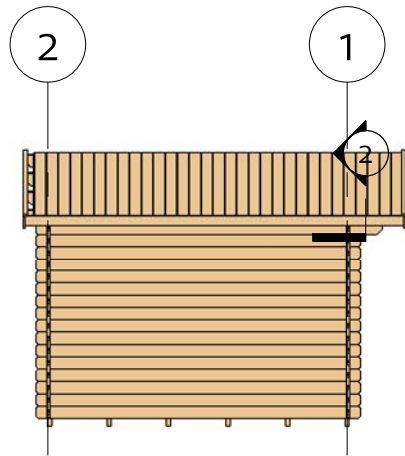

3) Roof Reinforcement

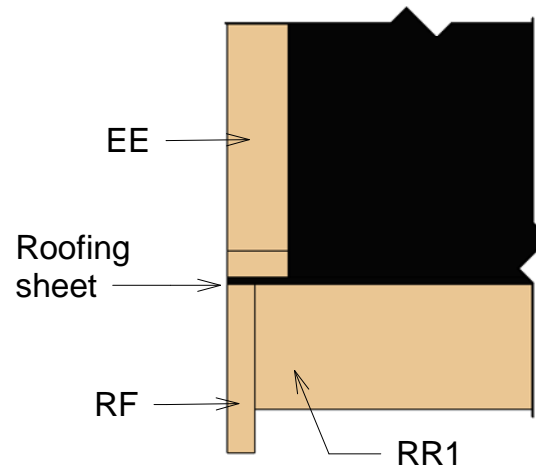

Fascia Schedule				
Mark	Type	Profile	Count	Length
EE	Eave Edging 18x40		4	2260
RF	Roof Fascia 18x115		4	2260
RR1	Roof reinforcement 18x90		2	3500
RR2	Roof reinforcement 38x38		2	3500

Elisabeth 28 (380x280)

Extras



Door Schedule				
Model	Type	Width	Height	Count
BDD5R	Basic double door 5 right	1425	1835	1
DCB6	Door crossbar 6	--	--	2

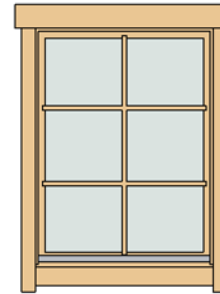

Window Schedule				
Model	Type	Width	Height	Count
BW1R	Basic window 1 right	765	990	1
BW1L	Basic window 1 left	765	990	1
WCB6	Window crossbar 6	--	--	2

Fasteners/Extras		
Name	Type	Count

Hitblock	300-400 mm	
Bolts	M8 x 60	12
Screws	5,0 x 70	15
nails	1,4 x 40	30
Screws	6,0 x 140	35
Screws	4,0 x 40	60
Screws	4,0 x 50	510

Type	Count	Lenght
Windboard 18x40	4	1900



Family	Count
Romb	2

4000011_190220

Elisabeth 28 (380x280)

List of all items 1

Impregnated foundation beams

Mark	Type	Profile	Count	Length
------	------	---------	-------	--------

IFB	IFB 40x70		6	3790
-----	--------------	---	---	------



Floor Schedule

Mark	Type	Profile	Count	Length
------	------	---------	-------	--------

FB	FB 18x110		35	2740
BB1	BB 20x40		2	3800
BB2	BB 20x40		2	2800





Roof

Mark	Type	Profile	Count	Length
------	------	---------	-------	--------

RFR	Ridge 40x120		1	3500
RFB	Beam 40x120		4	3500
RB	18x110		66	2220

Fascia Schedule

Mark	Type	Profile	Count	Length
------	------	---------	-------	--------

EE	Eave Edging 18x40		4	2260
RF	Roof Fascia 18x115		4	2260
RR1	Roof reinforcement 18x90		2	3500
RR2	Roof reinforcement 38x38		2	3500

Elisabeth 28 (380x280)

List of all items 2

Wall 1			
Mark	Profile	Count	Cut Length

1BL 1	28x57	2	1280
1LG 1	28x114	18	190
1LG 2	28x114	18	320
1LG 3 *	28x114	1	841
1LG 4 *	28x114	1	1683
1LG 5	28x114	14	1280
1LG 6 *	28x114	1	2477
1LG 7 *	28x114	1	3367
1LG 8 *	28x114	1	4000

Wall 2			
Mark	Profile	Count	Cut Length

2BL 1	28x114	1	4000
2LG 1 *	28x114	1	841
2LG 2 *	28x114	1	1683
2LG 3 *	28x114	1	2477
2LG 4 *	28x114	1	3367
2LG 5 *	28x114	1	4000
2LG 6	28x114	16	4000

*Gable-delivered premounted

Wall A			
Mark	Profile	Count	Cut Length

ALG 1	28x114	15	3000
ALG 2	28x114	1	3200
ATL 1	28x120	1	3500

Wall B			
Mark	Profile	Count	Cut Length

BLG 1	28x114	15	3000
BLG 2	28x114	1	3200
BTL 1	28x120	1	3500

Log Profiles	
Profile	Profile

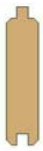
28x57	
28x114	
28x120	